

tbs electronics

THE POWER OF QUALITY



Product catalog

Professional power systems equipment
for renewable energy, back-up power
and vehicle applications



Introduction

TBS Electronics BV (TBS) is a privately owned ISO 9001:2015 certified Dutch company founded in 1984. TBS can best be described as an engineering driven family business.

It all started with the design and production of toroidal transformers, followed by electronics and software design in the early nineties.

Until 2006, TBS mainly operated as an Original Design Manufacturer (ODM) for other companies. But after that, our focus was shifted towards designing and marketing TBS branded equipment. Over the past years we have successfully worked on a comprehensive lineup of power conversion and instrumentation products, intended for use in independent power applications. All designed and manufactured in The Netherlands.

Our current product lineup consists of professional sinewave inverters, battery chargers, inverter-charger combinations, battery monitors and DC protection or distribution products. All these products have an excellent reputation for reliability and innovation. In the coming years we will further expand and optimize our product portfolio.



What's new in this edition

Omnicharge Solar, smart MPPT charge controllers
(page 20)



High efficiency solar charge controllers with Maximum Power Point Tracking (MPPT) and Bluetooth connectivity.

48V versions of the RBS and TBP relays
(page 48)



We are now also offering 48V versions of the DCM Remote Battery Switch and Battery Protect Relays.

NMEA2000 interface for the Expert Modular
(page 38)

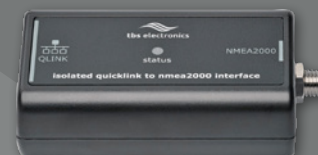

This kit enables you to readout the Expert Modular battery monitor through an NMEA2000 network and creates the possibility to show extensive battery bank data on any NMEA2000 compatible display.

Index

4

Powersine true sinewave inverters

300-12, 350-24 and 450-48
600-12, 800-24 and 800-48
1000-12, 1400-24, 1600-12, 1800-24 and 1800-48
2000-12, 2500-24, 3000-12, 3500-24 and 3500-48

14

Omnicharge programmable battery chargers

12-40, 12-60, 24-20 and 24-30
12-90, 24-50, 24-80 and 48-40
100-20, 100-30, 100-50, 150-60 and 250-70
12/12-50 and 12/24-30

24

Powersine Combi inverter/charger units

1600-12-60 and 1800-24-35
2000-12-80, 2500-24-50, 3000-12-120 and 3500-24-70

30

Expert Series high precision battery monitors

Lite, Pro and Pro-hv
Modular

40

DC Modular high current busbars, fuseholders and contactors

Premium quality Busbars, Fuseholders and Contactors

52

Other products

DC to DC converters
Automatic Charging Relay
Battery Protect Relays



Powersine true sinewave inverters

Provides pure sine wave AC power from a DC source

More than 20 years ago, TBS introduced the first Powersine true sinewave inverter that offered clean reliable power in a compact, yet affordable package. Since then our inverter lineup has evolved into a fine selection of different models, that are used worldwide in a wide variety of applications.

An inverter transforms the DC electricity stored in batteries into standard household AC power. With a Powersine inverter you don't have to rely on hard-to-find DC-powered appliances or a noisy generator to enjoy the comforts of home in your vehicle, RV or boat. Creating an independent mobile power system and providing silent AC electricity anytime, anywhere.

Powersine inverters are efficient and reliable and come in a variety of sizes and power ranges to meet just about any power need. We offer small models designed for lower power AC loads such as TV's, computers and electric tool chargers, plus high power units that provide electricity for larger installations in for example vehicles and boats.

Cleaner than grid power

With very low total harmonic distortion, a Powersine inverter delivers a true sine wave output that is identical or even better than the AC power supplied by the public grid. Grid power is more likely to fluctuate causing your lights to flicker. Sometimes the voltage may even drop down to a level that affects proper operation of your connected equipment. This is especially true for shore power outlets. Due to the perfect and stable AC output of a Powersine inverter, all such problems no longer exist and also helps to protect your equipment against failures, humming or interference.





Technology without compromise

All Powersine inverters are built around the superior hybrid HF/LF technology using a single power stage and a very efficient toroidal transformer. This offers many benefits like:

- Very high peak power delivery
- Low no-load power consumption
- Capable of powering the most difficult loads
- Less active components = higher reliability

Additionally, only first class components are used inside any Powersine inverter. Ensuring a long trouble-free lifetime. This is proven by the fact that large numbers of our first generation inverters are still in service today.

System design flexibility

Using a stand-alone inverter offers you all the freedom to choose the best battery charging source for your application. Determine the right current rating to match your battery capacity and desired charging time, or choose to charge from an alternator, the grid or the sun.

Powersine

300-12, 350-24 and 450-48



Description

The PS300-12, PS350-24 and PS450-48 professional DC to AC true sine wave inverters, offer superior performance for a wide range of applications.

Unlike many other inverters, the very clean and interference free output of a Powersine inverter ensures correct operation of sensitive equipment like displays, test equipment and battery chargers.

The very robust electronic and mechanical design, make the Powersine inverter series the best choice for reliability. Designed for an extremely long lifespan and protected against short circuits, overloading and high temperatures, a Powersine inverter will deliver trouble free operation for many years.

The newest available technology results in extremely efficient operation with very low 'no-load' consumption. The Automatic Standby Function (ASB), standard in all Powersine inverters, will even reduce the no-load consumption by an extra 70%!

All Powersine inverters are easy to install and operate. Each Powersine inverter comes standard with DC cables and a very clear installation and operating instruction manual.

Features

- True sine wave AC output
- Robust design
- High surge power output
- Very efficient
- Protected against low battery voltage, high temperature, overload and short circuit
- Automatic Standby function to reduce no-load power consumption
- Variable speed fan for silent operation
- Schuko type AC outlet (other outlet types are optionally available)
- 1.5 meters DC connection cable included
- CE and e-mark certified
- 24 month warranty

Applications

- Recreational vehicles
- Marine applications
- Solar power systems
- Industrial systems
- Mobile entertainment systems
- Service vehicles
- Remote homes

Designed to power your...

- TV
- Computer
- Battery charger
- Portable work light
- Test & measurement equipment
- Smart phone charger
- Thermal printer



Technical specifications

Parameter		PS300-12 art # 5003000-1	PS350-24 art # 5003100-1	PS450-48 art # 5003300-1
Output power ¹⁾	P _{nom}	250W	300W	300W
	P _{10minutes}	330W	360W	450W
	P _{surge}	700W	800W	800W
Output voltage		230Vac ± 2% (115Vac ± 2% optional)		
Output frequency		50Hz ± 0.05% (60Hz ± 0.05% optional)		
Input voltage (±3% tolerance) Nominal		12Vdc	24Vdc	48Vdc
	Range	10.5 ²⁾ – 16.0Vdc	21.0 ²⁾ – 31.0Vdc	41.0 ²⁾ – 60.0Vdc
Maximum efficiency		91%	93%	95%
No load power consumption ³⁾		<3W	<3.5W	<6.5W
	[ASB]	[0.7W]	[0.8W]	[1.3W]
ASB threshold		P _{out} =12W	P _{out} =15W	P _{out} =15W
Operating temperature range (ambient)		-20°C ... +50°C (humidity max. 95% non condensing)		
Storage temperature range		-40°C ... +80°C (humidity max. 95% non condensing)		
Cooling		Variable speed fan controlled by temperature and load		
Communication port		No		
Protected against		Short circuit, overload, high temperature, low battery voltage		
Indications		Power on, error and ASB mode		
DC input connections		Two wires, length 1.5 meters, 4 mm ²		
AC output connections		Schuko outlet ⁴⁾		
Enclosure body size		184 x 98 x 130 mm (without mounting brackets)		
Total weight		3.5 kg		
Protection class		IP20		
Standards		CE marked meeting EMC directive 2014/30/EU and LVD 2014/35/EU complying with EN60335-1, e4-95/54/EC, RoHS 2011/65/EU		

Note: the given specifications are subject to change without notice.

¹⁾ Measured with resistive load at 25°C ambient. Power ratings are subject to a tolerance of 4% and are decreasing as temperature rises with a rate of approx. 1.2%/°C starting from 25°C

²⁾ Undervoltage limit is dynamic. This limit decreases with increasing load to compensate the voltage drop across cables and connections

³⁾ Measured at nominal input voltage and 25°C

⁴⁾ Also available are the following AC outlet types:



BS 1363



AS/NZS 3112

Powersine

600-12, 800-24 and 800-48



Description

The PS600-12, PS800-24 and PS800-48 professional DC to AC true sinewave inverters, offer superior performance for a wide range of applications.

Unlike many other inverters, the very clean and interference free output of a Powersine inverter ensures correct operation of sensitive equipment like displays, test equipment and battery chargers.

The very robust electronic and mechanical design, make the Powersine inverter series the best choice for reliability. Designed for an extremely long lifespan and protected against short circuits, overloading and high temperatures, a Powersine inverter will deliver trouble free operation for many years.

The newest available technology results in extremely efficient operation with very low 'no-load' consumption. The Automatic Standby Function (ASB), standard in all Powersine inverters, will even reduce the no-load consumption by an extra 70%!

All Powersine inverters are easy to install and operate. Each Powersine inverter comes standard with DC cables and a very clear installation and operating instruction manual.

Features

- True sinewave AC output
- Robust design
- High surge power output
- Very efficient
- Protected against low battery voltage, high temperature, overload and short circuit
- Automatic Standby function to reduce no-load power consumption
- Variable speed fan for silent operation
- Schuko type AC outlet (other outlet types are optionally available)
- Remote on/off capability
- 1.5 meters DC connection cable included
- CE and e-mark certified
- 24 month warranty

Applications

- Recreational vehicles
- Marine applications
- Solar power systems
- Industrial systems
- Mobile entertainment systems
- Service vehicles
- Remote homes

Designed to power your...

- TV
- Computer
- Battery charger
- Portable work light
- Test & measurement equipment
- Smart phone charger
- Thermal printer
- Small kitchen appliance
- Electric tool



Technical specifications

Parameter		PS600-12 art # 5004000-1	PS800-24 art # 5004100-1	PS800-48 art # 5004300-1
Output power¹⁾	Pnom	500W	600W	600W
	P10minutes	600W	800W	800W
	Psurge	1000W	1200W	1250W
Output voltage		230Vac ± 2% (115Vac ± 2% optional)		
Output frequency		50Hz ± 0.05% (60Hz ± 0.05% optional)		
Output waveform		True sinewave (THD < 5% ¹⁾ @ Pnom)		
Input voltage (±3% tolerance)	Nominal	12Vdc	24Vdc	48Vdc
	Range	10.5 ²⁾ – 16.0Vdc	21.0 ²⁾ – 31.0Vdc	41.0 ²⁾ – 60.0Vdc
Maximum efficiency		92%	93%	94%
No load power consumption³⁾		<4.8W	<6.5W	<8.2W
	[ASB]	[0.4W]	[0.7W]	[0.5W]
ASB threshold		Pout=15W		
Operating temperature range (ambient)		-20°C ... +50°C (humidity max. 95% non condensing)		
Storage temperature range		-40°C ... +80°C (humidity max. 95% non condensing)		
Cooling		Variable speed fan controlled by temperature and load		
Communication port		No		
Protected against		Short circuit, overload, high temperature, low battery voltage		
Indications		Power on, error and ASB mode		
DC input connections		Two wires, length 1.5 meters, 10 mm ²		
AC output connections		Schuko outlet ⁴⁾		
Enclosure body size		228 x 113 x 163 mm (without mounting brackets)		
Total weight		6.2 kg		
Protection class		IP20		
Standards		CE marked meeting EMC directive 2014/30/EU and LVD 2014/35/EU complying with EN60335-1, e4-95/54/EC, RoHS 2011/65/EU		

Note: the given specifications are subject to change without notice.

¹⁾ Measured with resistive load at 25°C ambient. Power ratings are subject to a tolerance of 4% and are decreasing as temperature rises with a rate of approx. 1.2%/°C starting from 25°C

²⁾ Undervoltage limit is dynamic. This limit decreases with increasing load to compensate the voltage drop across cables and connections

³⁾ Measured at nominal input voltage and 25°C

⁴⁾ Also available are the following AC outlet types:



BS 1363



AS/NZS 3112



Powersine

1000-12, 1400-24, 1600-12,
1800-24 and 1800-48



Description

The PS1000-12 up to PS1800-48 professional DC to AC true sinewave inverters, offer superior performance for a wide range of applications. Unlike many other inverters, the very clean and interference free output of a Powersine inverter ensures correct operation of sensitive equipment like displays, test equipment and battery chargers.

The very robust electronic and mechanical design, make the Powersine inverter series the best choice for reliability. Designed for an extremely long lifespan and protected against short circuits, overloading and high temperatures, a Powersine inverter will deliver trouble free operation for many years.

The newest available technology results in extremely efficient operation with very low 'no-load' consumption. The Automatic Standby Function (ASB), standard in all Powersine inverters, will even reduce the no-load consumption by an extra 70%!

All Powersine inverters are easy to install and operate. Each Powersine inverter comes standard with DC cables and a very clear installation and operating instruction manual.

Features

- True sinewave AC output
- Robust industrial design
- High surge power output
- Very efficient
- Protected against high/low battery voltage, high temperature, overload, short circuit and high ripple voltage
- Automatic Standby function to reduce no-load power consumption
- Variable speed fan for silent operation
- Remote on/off capability
- Alarm relay
- Remote control capability via TBSLink
- Easy to access connection bay for installing AC-, DC and control wiring
- 1.5 meters DC connection cable included
- CE certified
- 24 month warranty

Applications

- Recreational vehicles
- Marine applications
- Solar power systems
- Industrial systems
- Mobile entertainment systems
- Service vehicles



Technical specifications

Parameter		PS1000-12 art # 5006100	PS1400-24 art # 5006120	PS1600-12 art # 5006300	PS1800-24 art # 5006320	PS1800-48 art # 5006360
Output power¹⁾	Pnom	850W	1000W	1300W	1400W	1400W
	P10minutes	1050W	1450W	1600W	1800W	1800W
	Psurge	2000W	2800W	2500W	3000W	3000W
Output voltage		230Vac ± 2%				
Output frequency		50Hz or 60Hz ± 0.05% (selectable)				
Output waveform		True sinewave (THD < 5%1) @ Pnom)				
Input voltage (±3% tolerance)	Nominal	12Vdc	24Vdc	12Vdc	24Vdc	48Vdc
	Range	10.5 ²⁾ – 16.0Vdc	21.0 ²⁾ – 31.0Vdc	10.5 ²⁾ – 16.0Vdc	21.0 ²⁾ – 31.0Vdc	41.0 ²⁾ – 60.0Vdc
Maximum efficiency		92%	92%	92%	92%	94%
No load power consumption³⁾		<9.6W	<12W	<9.6W	<12W	<12W
	[ASB]	[2.5W]	[3.5W]	[2.5W]	[3.5W]	[4.7W]
ASB threshold		Pout=10W				
Operating temperature range (ambient)		-20°C ... +50°C (humidity max. 95% non condensing)				
Storage temperature range		-40°C ... +80°C (humidity max. 95% non condensing)				
Cooling		Variable speed fan controlled by temperature and load				
Communication port		TBSLink (readout only)				
Protected against		Short circuit, overload, high temperature, AC back feed, high/low battery voltage and high input ripple voltage				
Indications		Power on, output power bar, error and ASB mode				
DC input connections (cable length 1.5m)		PS1000-12 / PS1400-24 / PS1800-48: 2 x 25 mm ²		PS1600-12 / PS1800-24: 2 x 35 mm ²		
AC output connections		Screw terminals				
Enclosure body size		351 x 210 x 114 mm				
Total weight		PS1000-12 / PS1400-24: 10.2 kg		PS1600-12 / PS1800-24 / PS1800-48: 10.5 kg		
Protection class		IP21 (mounted in upright position)				
Standards		CE marked meeting EMC directive 2014/30/EU and LVD 2014/35/EU complying with EN60335-1, e4-95/54/EC, RoHS 2011/65/EU				

Note: the given specifications are subject to change without notice.

¹⁾ Measured with resistive load at 25°C ambient. Power ratings are subject to a tolerance of 10% and are decreasing as temperature rises with a rate of approx. 1.2%/°C starting from 25°C

²⁾ Undervoltage limit is dynamic. This limit decreases with increasing load to compensate the voltage drop across cables and connections

³⁾ Measured at nominal input voltage and 25°C

Accessories

- Universal Remote Control with LCD
- Basic Remote Control with LEDs
- TBSLink communication kit including software



Basic Inverter Remote Control, art # 5095200



Universal Remote Control, art # 5095500



TBSLink to USB Interface Kit, art # 5092120
(Includes TBS Dashboard for monitoring the Powersine inverters)

Powersine

2000-12, 2500-24, 3000-12,
3500-24 and 3500-48



Description

The PS2000-12 up to PS3500-48 professional DC to AC true sinewave inverters, offer superior performance for a wide range of applications. Unlike many other inverters, the very clean and interference free output of a Powersine inverter ensures correct operation of sensitive equipment like displays, test equipment and battery chargers.

The very robust electronic and mechanical design, make the Powersine inverter series the best choice for reliability. Designed for an extremely long lifespan and protected against short circuits, overloading and high temperatures, a Powersine inverter will deliver trouble free operation for many years.

The newest available technology results in extremely efficient operation with very low 'no-load' consumption. The Automatic Standby Function (ASB), standard in all Powersine inverters, will even reduce the no-load consumption by an extra 70%!

All Powersine inverters are easy to install and operate. Due to smart connection bay mapping of AC, DC and control connectors, all wiring can be installed in a fast and logical way.

Features

- True sinewave AC output
- Robust industrial design
- High surge power output
- Very efficient
- Protected against high/low battery voltage, high temperature, overload, short circuit and high ripple voltage
- Variable speed fan for silent operation
- Remote on/off capability
- Alarm relay
- Remote control capability via TBSLink
- Easy to access connection bay for installing AC-, DC and control wiring
- Trigger input
- CE certified
- 24 month warranty

Applications

- Recreational vehicles
- Marine applications
- Solar power systems
- Industrial systems
- Mobile entertainment systems
- Service vehicles
- Remote homes



Accessories

- Universal Remote Control with LCD
- Basic Remote Control with LEDs
- TBSLink communication kit including software



Basic Inverter Remote Control, art # 5095200



Universal Remote Control, art # 5095500



TBSLink to USB Interface Kit, art # 5092120
(Includes TBS Dashboard for monitoring the Powersine inverters)

Technical specifications

Parameter		PS2000-12 art # 5008100	PS2500-24 art # 5008120	PS3000-12 art # 5008300	PS3500-24 art # 5008320	PS3500-48 art # 5008360
Output power ¹⁾	P _{nom}	1800W	2000W	2600W	2800W	2800W
	P _{10minutes}	2100W	2500W	3200W	3800W	3800W
	P _{surge}	4000W	5500W	5000W	6500W	6500W
Output voltage		230Vac ± 2%				
Output frequency		50Hz or 60Hz ± 0.05% (selectable)				
Output waveform		True sinewave (THD < 5% ¹⁾) @ P _{nom})				
Input voltage (±3% tolerance)	Nominal	12Vdc	24Vdc	12Vdc	24Vdc	48Vdc
	Range	10.0 ²⁾ – 16.5Vdc	20.0 ²⁾ – 33.0Vdc	10.0 ²⁾ – 16.5Vdc	20.0 ²⁾ – 33.0Vdc	40.0 ²⁾ – 64.0Vdc
Maximum efficiency		92%	93%	92%	93%	93%
No load power consumption ³⁾		<19W	<20W	<19W	<20W	<21W
[ASB]		[2.0W]	[2.0W]	[2.0W]	[2.0W]	[2.4W]
ASB threshold		P _{out} =10W				
Operating temperature range (ambient)		-20°C ... +50°C (humidity max. 95% non condensing)				
Storage temperature range		-40°C ... +80°C (humidity max. 95% non condensing)				
Cooling		Variable speed fan controlled by temperature and load				
Communication port		TBSLink (readout only)				
Protected against		Short circuit, overload, high temperature, AC back feed, high/low battery voltage and high input ripple voltage				
Indications		Power on, output power bar, error and ASB mode				
DC input connections		M10 bolt terminals				
AC output connections		Screw terminals				
Enclosure body size		370 x 431 x 132 mm				
Total weight		18.2 kg			18.5 kg	
Protection class		IP21 (mounted in upright position)				
Standards		CE certified (EMC Directives UNECE Regulation 10 and 2014/30/EU, Low voltage Directive 2014/35/EU, RoHS Directive 2011/65/EU)				

Note: the given specifications are subject to change without notice.

¹⁾ Measured with resistive load at 25°C ambient. Power ratings are subject to a tolerance of 10% and are decreasing as temperature rises with a rate of approx. 1.2%/°C starting from 25°C

²⁾ Undervoltage limit is dynamic. This limit decreases with increasing load to compensate the voltage drop across cables and connections

³⁾ Measured at nominal input voltage and 25°C

BATTERY CHARGER

programmable automatic battery cha

Omnicharge programmable battery chargers



Charge your batteries quickly and safely

More than a decade ago, the Omnicharge battery chargers set new standards by combining a true continuous duty capable power section, with almost unlimited programming capabilities. This made these units a popular choice for applications that require extensive daily bulk charging or specific charge programs to fit the connected batteries.

All Omnicharge battery chargers operate fully automatically, so that batteries, if desired, can always stay connected to it. The charger will automatically detect when a recharge is needed. Alternatively, it will also detect when a battery is fully charged, so that the charge voltage can be reduced in order to increase the battery's lifetime and avoid battery self-discharge.

The current Omnicharge lineup contains 12V chargers with 40A, 60A and 90A outputs, 24V chargers with 20A, 30A, 50A and 80A outputs and a powerful 48V charger with 40A charge capacity. Additionally, we are also offering MPPT solar charge controllers with 100Vdc to 250Vdc inputs and 12Vdc up to 48Vdc outputs. And the lineup is closed by DC to DC battery chargers with a 12Vdc input and 12Vdc or 24Vdc outputs.

Switch mode technology done correctly

Having a long history in switch mode power supply design, we know all common pitfalls that can result in poor reliability, short product lifetimes, low efficiency and poor radio frequency interference performance.

Each Omnicharge battery charger is very carefully designed with great attention to detail. For example, PCB and capacitor hot spots are avoided to increase long term reliability and efficiency. All power semiconductor are properly decoupled for radio frequencies and are well over dimensioned. Internal thermal management is perfectly optimized to avoid the charge current to drop due to internal overheating.

Furthermore, each AC powered Omnicharge product is equipped with active power factor correction and smart internal rectifiers for optimal efficiency and a maximum charge current per AC Watt. A universal AC input on most models enables correct operation all around the globe and guarantees a maximum charge current even under low AC input voltage conditions.





The best battery charger for every application

All AC powered Omnicharge battery chargers are equipped with three outputs. This allows three battery banks to be charged at once. The high power Omnicharge models have three equal charge outputs that automatically redirect the available power to the lowest battery, for faster charging.

The medium power Omnicharge² models have three fully independent outputs. Each output has individually programmable charge voltages, currents and stages. This enables the possibility to charge a combination of different battery types and sizes by a single battery charger.

Lithium batteries

The use of Lithium Ion batteries is strongly growing in many different applications. Omnicharge battery chargers can seamlessly charge Lithium Ion batteries with the correct charging voltage. When the required charging voltage still differs from the standard available ones, these can be easily modified via the TBS Dashboard software or on the unit's display (Omnicharge² only). All chargers are also equipped with a remote shut down input, which can be used for allowing a Lithium battery BMS to stop the charging process.

Omnicharge²

12-40, 12-60, 24-20 and 24-30

programmable automatic battery charger



Description

The Omnicharge² 12-40, 12-60, 24-20 and 24-30 are fully programmable, three output, automatic battery chargers designed for professional applications. A clear backlit display shows the charge progress as well as the actual charge voltage and current for each output.

Combining the latest technologies and the best available parts with years of power electronics design expertise, the Omnicharge² battery chargers will deliver long life performance even in the most demanding applications. Utilizing high efficiency converter technology, will reduce running costs and guarantees a maximum charge current per AC Watt.

A unique new feature of the Omnicharge² range is the autonomous

battery output setup. All outputs are not only isolated from each other, but these are also individually programmable. This enables the possibility to charge a combination of different battery types and sizes by a single battery charger.

All Omnicharge² models are equipped with advanced temperature compensated charge programs, with or without a float stage. Standard available are

AGM, GEL, Flooded and Lithium charge programs. Each charge program can also be modified to different voltage and current levels in case the connected battery has special requirements. Also available is a 'Night Mode', which prevents the fans from spinning when absolute silence is desired.

All Omnicharge² units are easy to install and come standard with temperature sensor and a very clear installation and operating instruction manual.

Features

- Three full current outputs (Individually programmable)
- Robust industrial design
- Clear backlit display for easy readout and configuration
- Designed for continuous duty charging
- Very efficient
- Universal power factor corrected auto ranging AC input
- No charge current derating at 115VAC input
- Protected against battery failure, high temperature, overload, short circuit, low input voltage and reverse polarity
- Protects the battery from being overcharged
- Variable speed fan for low noise operation
- Remote on/off capability (for interfacing to external BMS)
- QuickLink communication port
- Night Mode for silent operation
- Easy to access connection bay for installing AC-, DC and control wiring
- Temperature sensor included
- CE certified
- 24 month warranty

Applications

- Recreational vehicles
- Marine applications
- Industrial systems
- Mobile entertainment systems
- Service vehicles
- Remote homes



Technical specifications

Parameter	OC12-40 art # 5026202-1	OC12-60 art # 5026402-1	OC24-20 art # 5026222-1	OC24-30 art # 5026422-1
Input voltage	90-265Vac / 47-63Hz / PF ≥ 0.95			
Full load consumption	700VA	1050VA	700VA	1050VA
AC input current (115V/230V)	6A/3A	9A/4.5A	6A/3A	9A/4.5A
Full load efficiency	> 82%			
Nominal output voltage ¹⁾	12Vdc		24Vdc	
Total output current ^{1) 4)}	40A	60A	20A	30A
Number of full current outputs	3 (internally isolated, individually programmable)			
Charge characteristic ²⁾	IUoUoP, intelligent 4-stage, temperature compensated			
Absorption voltage ²⁾	14.4Vdc		28.8Vdc	
Float voltage ²⁾	13.5Vdc		27.0Vdc	
Equalize voltage ²⁾	15.5Vdc		31.0Vdc	
Supported Battery types ²⁾	GEL / AGM / Flooded / LiFePO4 (programmable per output)			
Recommended battery capacity ³⁾	80-400Ah	120-600Ah	50-200Ah	70-300Ah
DC current draw (charger off)	< 2mA			
Operating temp. range ⁴⁾	-20°C ... +60°C (humidity max. 95% non condensing)			
Storage temp. range	-40°C ... +70°C (humidity max. 95% non condensing)			
Cooling	Variable speed fan controlled by temperature and load			
Communication port	QuickLink			
Protected against	Low AC voltage, output short circuit, high temperature, battery overcharging and reverse battery polarity			
Indications	LCD showing charging status, voltage- and current levels, error			
DC output connections	M6 studs (3x positive, 1x common negative)			
AC input connections	Fixed AC cord with Schuko plug (1.5 meter length)			
Enclosure body size (L x W x H)	295 x 206 x 86mm	356 x 206 x 99mm	295 x 206 x 86mm	356 x 206 x 99mm
Total weight	3.0 kg	4.0 kg	3.0 kg	4.0 kg
Protection class	IP32			
Standards	CE marked meeting EMC directive 2014/30/EU and LVD 2014/35/EU complying with EN60335-1, EN60335-2-29 and RoHS 2011/65/EU			

Note: the given specifications are subject to change without notice.

¹⁾ Maximum output current tolerance is +/-3%. Maximum setpoint voltage deviations are +/- 0.1V for 12V and +/- 0.2V for 24V models. All setpoint voltages are temperature compensated when battery temperature sensor is connected.

²⁾ Value is programmable

³⁾ Always consult battery manufacturers specifications for maximum allowable charge current

⁴⁾ At higher ambient temperatures (>40°C), maximum output current may be reduced automatically

Accessories

- QuickLink to RS-232 Communication Kit, art # 5092030
- QuickLink to USB Communication Kit, art # 5092130 (Includes TBS Dashboard 2 for monitoring and programming the Omnicar² chargers)
- QuickLink to Bluetooth Communication Kit, art # 5092230 (Dashboard Mobile app available in Apple App Store and Google Play)

QuickLink to RS-232
Communication Kit,
art # 5092030



QuickLink to USB
Communication Kit,
art # 5092130



QuickLink to Bluetooth
Communication Kit,
art # 5092230



Omnicharge

12-90, 24-50, 24-80 and 48-40

BATTERY CHARGER

programmable automatic battery charger



www.tbs-electronics.com



Description

The Omnicharge 12-90, 24-50, 24-80 and 48-40 are fully programmable, automatic battery chargers designed for professional applications.

Combining the latest technologies and the best available parts with years of power electronics design expertise, the Omnicharge battery chargers will deliver long life performance even in the most demanding applications. A unique active rectifier output stage ensures unmatched efficiency figures. Combined with active PFC, the Omnicharge battery chargers are very energy efficient. This will reduce running costs and guarantees a maximum charge current per AC Watt.

Up to six charger units can be connected in parallel, allowing synchronized charging with currents up to 540A. Three separate battery banks can be charged simultaneously, thanks to the triple output design.

All Omnicharge models are equipped with advanced temperature compensated charging programs for lead acid and lithium based batteries. Besides easily selectable standard charge

programs, users are also allowed to create a custom charging program using the TBS Dashboard software. The standard available TBSLink port enables connection to a number of accessories like the TBS remote controls.

All Omnicharge units are easy to install and come standard with temperature sensor and a very clear installation and operating instruction manual.

Features

- Three full current outputs
- Robust industrial design
- Designed for continuous duty charging
- Very efficient
- Universal power factor corrected auto ranging AC input
- Parallel capability up to 6 units
- Protected against battery failure, high temperature, overload, short circuit, low input voltage and reverse polarity (fuse)
- Multistage intelligent charging programs
- Programmable charging programs up to 8 stages
- Protects the battery from being overcharged
- Variable speed fan for silent operation
- Remote on/off capability (for interfacing to external BMS)
- Alarm relay (optional Alarm Output Expander available for additional relays)
- Remote control capability via TBSLink
- Easy to access connection bay for installing AC-, DC and control wiring
- Temperature sensor included
- CE certified
- 24 month warranty

Applications

- Recreational vehicles
- Marine applications
- Industrial systems
- Mobile entertainment systems
- Service vehicles
- Remote homes



Technical specifications

Parameter	OC12-90 art # 5027200	OC24-50 art # 5027220	OC24-80 art # 5027420	OC48-40 art # 5027440
Input voltage	100-260Vac / 47-63Hz / PF ≥ 0.90		180-260Vac / 47-63Hz / PF ≥ 0.90	
Full load consumption	1550VA	1700VA	2750VA	2750VA
AC input current (115V/230V)	13.5A/6.8A	15A/7.5A	-/12A	-/12A
Nominal output voltage ¹⁾	12Vdc		24Vdc	48Vdc
Total output current ^{1) 4)}	90A	50A	80A	40A
Number of full current outputs	3 (internally isolated)			
Charge characteristic ²⁾	IUoUoP, intelligent 4-stage, temperature compensated			
Absorption voltage ²⁾	14.4Vdc		28.8Vdc	57.6Vdc
Float voltage ²⁾	13.5Vdc		27.0Vdc	54.0Vdc
Equalize voltage ²⁾	15.8Vdc		31.6Vdc	63.2Vdc
Supported Battery types ²⁾	Flooded / GEL / AGM / LiFePO4 / Custom			
Recommended battery capacity ³⁾	180-900Ah	100-500Ah	160-800Ah	80-400Ah
DC current draw (charger off)	< 0.1mA			
Operating temp. range ⁴⁾	-10°C ... +55°C (humidity max. 90% non condensing)			
Storage temp. range	-20°C ... +70°C (humidity max. 90% non condensing)			
Cooling	Variable speed fan controlled by temperature and load			
Communication port	TBSLink			
Protected against	Low AC voltage, output short circuit, high temperature, battery overcharging and reverse polarity (fuse)			
Indications	Power on, output current bar, state of charge bar, error			
DC output connections	4x M8 bolts			
AC input connections	Screw terminals			
Enclosure body size (L x W x H)	370 x 270 x 132mm			
Total weight	6.2 kg			
Protection class	IP21 (mounted in upright position)			
Standards	CE marked meeting EMC directive 2014/30/EU and LVD 2014/35/EU complying with EN60335-1, EN60335-2-29 and RoHS 2011/65/EU			

Note: the given specifications are subject to change without notice.

¹⁾ Maximum output current tolerance is +/-10%. Maximum setpoint voltage deviations are +/- 1%.

All setpoint voltages are temperature compensated when battery temperature sensor is connected.

²⁾ Value is programmable

³⁾ Always consult battery manufacturers specifications for maximum allowable charge current

⁴⁾ At higher ambient temperatures (>40°C), maximum output current may be reduced automatically

Accessories

- Universal Remote Control with LCD
- Basic Remote Control with LEDs
- TBSLink communication kit including software



Basic Charger Remote Control, art # 5095220

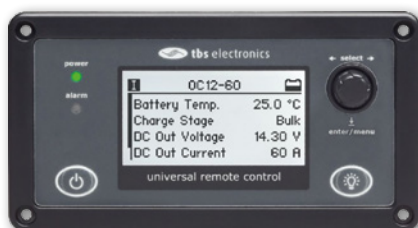

Universal Remote Control (Omnicharge), art # 5095500



TBSLink to USB Interface Kit, art # 5092120
(Includes TBS Dashboard for monitoring the Powersine inverters)

Omnicharge Solar

OCS 100-20, OCS 100-30, OCS 100-50,
OCS 150-60 and OCS 250-70

Description

The Omnicharge Solar 100-20, 100-30, 100-50, 150-60 and 250-70 are very high efficient solar charge controllers with Maximum Power Point Tracking (MPPT).

The Omnicharge Solar (OCS) MPPT solar charge controllers, are advanced and modern battery chargers for off-grid photovoltaic (PV) energy systems.

The OCS family offers solutions for PV array maximum power levels from 260Wp up to 3.6kWp and battery system voltages of 12V up to 48V.

Smart and rapid Maximum Power Point Tracking ensures the most efficient utilization of solar power to charge your batteries. An OCS controller can recognize multiple power points during partial shading or other mixed PV panel conditions. Under these circumstances the OCS controller will continuously make sure that maximum PV power is transferred to your batteries.

Very low self consumption and high resolution power control circuits ensure excellent performance at sunrise and low light levels.

The OCS controllers are highly efficient, reaching peak efficiency levels of respectively 98% and 99% for the conversion- and MPPT sections. This way PV power will be transferred to your batteries with minimum losses. But this also means that no cooling fans are needed and that the OCS controllers are running at respectable internal temperatures, resulting in a long lifetime.

Many protections are built-in, like for reverse battery- and PV connection, output short circuit, input power overload and high temperatures.

There are selectable charge programs available for Lithium, AGM, GEL and Flooded batteries. Additionally, a user defined charge program can also be selected and edited to fit your desired battery type.

Each OCS controller can be configured and readout using our Dashboard Mobile app for iOS and Android devices. This includes the display of 300 days of extensive history data.

All OCS controllers are very easy to install and come with clear instructions. A battery temperature sensor is included as standard for the OCS150-60 and 250-70 models.

Features

- Ultra fast Maximum Power Point Tracking (MPPT) ensures most efficient utilization of solar power to charge your batteries
- Smart selectable charge programs for AGM, Gel, Flooded, Lithium and User defined battery types
- Monitoring and configuration via Dashboard Mobile app (iOS and Android)
- Highly efficient fanless design
- Automatic battery voltage detection
- Battery temperature sensor input
- Historical data storage up to 300 days
- Fully protected against: battery reverse polarity, PV reverse polarity, short circuits, battery open circuit and charge controller overtemperature
- Detachable information display (OCS150-60 and 250-70 only)

Applications

- Stationary off-grid solar systems
- Recreational vehicles
- Marine applications
- Industrial systems



Technical specifications

Parameter	OCS 100-20 art # 5024200	OCS 100-30 art # 5024300	OCS 100-50 art # 5024500	OCS 150-60 art # 5024630	OCS 250-70 art # 5024770
System voltage	12V / 24V			12V / 24V / 36V / 48V	
Maximum charge current ¹⁾	20A	30A	50A	60A	70A
Self consumption	0.12W			0.54W	
Battery voltage range	9.0 – 32.0Vdc			9.0 – 64.0Vdc	
Max. PV open circuit voltage	100Vdc			150Vdc	250Vdc
Max. PV short circuit current	20A	30A	50A	50A	40A
MPPT voltage range	V _{batt} + 2 up to 75Vdc			V _{batt} + 2 up to 120Vdc	V _{batt} + 2 up to 180Vdc
Max. PV input power	12V	260W	400W	660W	800W
	24V	520W	800W	1320W	1600W
	36V	n/a	n/a	n/a	2400W
	48V	n/a	n/a	n/a	3200W
Charge characteristic	IUoUo, intelligent 3-stage, temp. compensated				
Supported battery types ²⁾	Flooded / GEL / AGM / LiFePO4 / Custom (user defined)				
Temperature compensation	-3mV / °C / Cell (lead based batteries only)				
Maximum conversion efficiency	98%				
Maximum MPPT efficiency	99%				
LED indicators	Charge mode, Battery state and Battery type				
Display	No			Yes (detachable for remote use)	
Battery temperature sensor	Optional ³⁾			Included	
Alarm relay	No			Yes (10A @ 230Vac or 30Vdc)	
Configuration	By Dashboard Mobile app for iOS and Android				
Cooling	Natural convection (no fan)				
Protections	Battery and PV reverse polarity, output short circuit and overtemperature				
Operating temperature	-35°C ... +60°C (humidity max. 90% non condensing)				
Storage temperature	-40°C ... +80°C (humidity max. 90% non condensing)				
Connections (PV + Battery)	Screw terminals (10mm ² / 8 AWG)			Screw terminals (35mm ² / 2 AWG)	
Dimensions (L x H x D)	150x106x62mm	150x106x68mm	183x127x70mm	266x194x119mm	
Weight	0.70kg	0.88kg	1.39kg	3.6kg	
Protection class	IP32 (mounted in upright position)				
Standards	CE marked meeting EMC directive 2014/30/EU, Safety EN62109-1, Functionality EN62509-1 and RoHS 2011/65/EU				

Note: the given specifications are subject to change without notice.

¹⁾ Maximum charge current tolerance is +/-5%. Automatic output current derating at Tambient > 45°C.

²⁾ Selectable by program switch or through Dashboard Mobile app. Custom battery type charge voltages can also be modified by the Dashboard Mobile app.

³⁾ An external battery temperature sensor is required when charge voltage compensation against varying temperature is desired.

Accessories

OCS Temperature Sensor Kit 3m



OCS Temperature Sensor Kit 3m, art # 5055319
Battery temperature sensor kit for the OCS controllers, with 3m cable length (provided as standard with the OCS 150 and 250 models).

Omnicharge DC

OCD 12/12-50 and OCD 12/24-30



Description

The Omnicharge DC battery chargers are primarily intended to charge an auxiliary or service battery from a vehicle starter battery. The input battery voltage can be above, below or equal to the output battery voltage. So the Omnicharge DC charger allows the auxiliary battery to be perfectly charged regardless of the input voltage, while being protected against damage due to peak voltages. All this cannot be offered by conventional charging relays or traditional fixed step-up / step-down converters.

The Omnicharge DC battery chargers are compatible with vehicles that are equipped with variable output smart alternators (EUR 6+). It can start to charge based on a programmable input voltage range only, or in combination with an engine run signal. There is also a separate (BMS-) control input available that enables external control for charger-on and -standby.

Best in class power density is offered by delivering a maximum of 900W from a very compact enclosure. Charge programs for most commonly used battery types are available, but these can also be customized via the Dashboard for Windows or Dashboard Mobile apps. Input start/stop voltages and delays are programmable as well, including the functionality of the status output.

All Omnicharge DC units are easy to install and come standard with a temperature sensor, cable lugs, cable grommets and clear installation and operating instructions.

Features

- Robust very compact industrial design
- Designed for continuous duty charging
- Protects the output battery
- Protects alternator when charging lithium batteries
- High efficiency
- Variable speed fan for low noise operation
- Simple intuitive LED indicators show the charger's status at a glance
- Fully programmable through QuickLink interface
- Remote on/off input (engine run)
- BMS control input
- Open collector status output
- Protected against high temperature, short circuit, high/low input voltage and reverse polarity
- Very easy installation
- Temperature sensor included
- CE certified
- 24 month warranty

Applications

- Recreational vehicles
- Marine applications
- Service vehicles
- Charge voltage drop compensation



Omnicharge DC connections side



Accessories



QuickLink to RS-232 Communication Kit
art # 5092030

Includes TBS Dashboard 2 for monitoring and programming the Omnicharge DC chargers



QuickLink to USB Communication Kit
art # 5092130

Includes TBS Dashboard 2 for monitoring and programming the Omnicharge DC chargers



QuickLink to Bluetooth Communication Kit art # 5092230

Dashboard Mobile app available in Apple App Store and Google Play



Technical specifications

Parameter	OCD 12/12-50 art # 5022400	OCD 12/24-30 art # 5022420
Nominal input voltage	12Vdc	
Input voltage range	10.0 - 16.0Vdc	
Maximum input current	65A _{dc}	
Current consumption (inactive)	< 0.25mA	
Current consumption (noload/standby)	< 35mA	< 45mA
Nominal output voltage	12Vdc	24Vdc
Output voltage range	12.0 - 16.0Vdc	24.0 - 32.0Vdc
Maximum output current ¹⁾	50A	30A
Charge characteristic	IUoUo, intelligent 3-stage, temp. compensated	
Supported battery types ²⁾	Flooded / GEL / AGM / LiFePO4	
Operating temperature range	-20°C ... +60°C	
Storage temperature range	-30°C ... +70°C	
Cooling	Variable speed fan	
Communication port	QuickLink	
Temperature sensor port	Yes (sensor included)	
Engine run / activate input port	Yes (> 2.0V = Active and < 1.0V = Inactive)	
BMS input port	Yes (> 3.0V = Standby and < 1.0V = Active, programmable polarity)	
Status output port	Yes (open drain, 32V / 150mA max, five assignable status types)	
Protections	High/low input voltage, high temperature, output short circuit and reverse battery polarity (input + output)	
Indications	Input status, output (charge-) status, error	
Battery connections	3x M6 screw terminal	
Enclosure body size (H x W x D)	70 x 128 x 170mm	
Total weight	1.2kg	
Protection class	IP21	
Standards	CE certified (EMC Directives UNECE Regulation 10 and 2014/30/EU, Low voltage Directive 2014/35/EU, RoHS Directive 2011/65/EU)	

Note: the given specifications are subject to change without notice.

¹⁾ Maximum output current tolerance is +/-10%. Automatic output current derating at Tambient > 40°C.

²⁾ Selectable by DIP switch. All standard charge voltages can also be modified by the TBS Dashboard application.





Powersine Combi inverter/ charger units

TBS Powersine Combi integrates a powerful inverter, a smart charger and an AC transfer switch in one robust and compact enclosure. An ideal power station solution for caravan, RV, marine, off-grid solar and many more applications.

A Powersine Combi recharges the house batteries when AC power from the grid or a generator is available at the input. The device also allows any surplus AC power to pass through and power downstream AC loads, such as a television or microwave oven. When there is no AC power available, the unit inverts DC battery power into clean true sinewave AC electricity. All this is done automatically and the AC transfer switch operates extremely fast, not disturbing any AC loads connected to the output.

High performance

Using hybrid HF/LF power conversion technology in combination with an ultra-fast Digital Signal Processor, results in a high performance inverter/charger combination. Powersine Combi units are equipped with the fastest and most accurate phase lock system in the market, allowing it to even operate correctly with very poor generators as AC source. The conservatively rated inverter delivers clean true sinewave power and has a very large peak power capability. The powerful charger section guarantees fast charging times, but also offers great flexibility by allowing many charge profile parameters to be customized through the TBS Dashboard software.

AC Input Power Boost

The Powersine Combi offers many innovative features like AC Input Power Boost. When more power is required than the grid or generator can provide, the Powersine Combi will supplement the shortage by automatically activating the inverter. Once the peak power demand has passed, the Powersine Combi ensures that the battery is being recharged again. This, for example, allows the use of a smaller generator which reduces the overall system costs.

Powerful Trigger-Action feature

An integrated power system solution is nothing without extensive programming possibilities. Besides configuring standard parameters like maximum charging current, shore current limit level etc., the Powersine Combi offers something unique called 'Trigger-Actions'. This is based on a so-called 'If This Then That' scheme, where a user selectable state, event or trigger can cause a certain action.

For example, you can configure to ignore incoming AC grid power as long as the battery voltage is above a certain level. This way you can prioritize (solar charged-) battery power above the metered grid power. Or you can set the Powersine Combi into a silent 'night mode' when one of the physically available trigger inputs is active. This Trigger-Action feature allows almost countless scenarios to be programmed inside the Powersine Combi.

Powersine Combi

1600-12-60 and 1800-24-35



Description

The PSC1600-12-60 and PSC1800-24-35 Powersine Combi products are based on the latest generation Powersine inverter engine, which guarantees very reliable operation and huge output power reserves. The Powersine Combi also features a powerful intelligent battery charger and an ultra fast AC transfer switch. All this is combined in a very compact, yet installer friendly unit.

The Powersine Combi offers many innovative features like AC Input Power Boost, which temporarily assists weak AC input sources when more power is needed than available. Another feature is AC Input Current Limit, which limits the maximum current consumed from the AC input source by the Powersine Combi in charger mode.

Furthermore, the Powersine Combi is equipped with a TBSLink port to connect to a remote control or to a Windows device running TBS Dashboard, for easy step by step configuration and readout.

Also available are a fully configurable alarm relay output and a unique trigger

input, that can convert external trigger commands into a number of Powersine Combi status changes.

Each Powersine Combi comes standard with DC cables, a temperature sensor and a very clear installation and operating instruction manual.

Features

- True sinewave AC output
- Robust industrial design
- High surge power output
- Powerful 4-stage battery charger
- Power factor corrected AC input
- Fast AC transfer switch
- AC Input Power Boost
- AC Input Current Limit
- Protected against high/low battery voltage, high temperature, overload, short circuit, high ripple voltage and low AC input voltage
- Automatic Standby function to reduce no-load power consumption
- Variable speed fan for silent operation
- Remote on/off capability
- Configurable alarm relay
- Versatile trigger input
- Remote control capability via TBSLink
- Easy to access connection bay for installing AC-, DC and control wiring
- 1.5 meters DC connection cable included
- CE certified
- 24 month warranty

Applications

- Recreational vehicles
- Marine applications
- Solar power systems
- Industrial systems
- Mobile entertainment systems
- Service vehicles
- Remote homes



Technical specifications

Parameter		PSC1600-12-60 art # 5016300	PSC1800-24-35 art # 5016320
Inverter stage			
Output power¹⁾	P _{nom}	1300W	1400W
	P _{10minutes}	1600W	1800W
	P _{surge}	2500W	3000W
Output voltage		230Vac ± 2%	
Output frequency		50Hz or 60Hz ± 0.05% (selectable)	
Output waveform		True sinewave (THD < 5%1) @ P _{nom}	
Input voltage (±3% tolerance)	Nominal	12Vdc	24Vdc
	Range	10.0 ²⁾ – 16.5Vdc	20.0 ²⁾ – 33.0Vdc
Maximum efficiency		92%	94%
No load power consumption³⁾ [ASB]		<10W [2.0W]	<12W [2.0W]
Charger stage			
AC input voltage		185 - 270Vac / 45 - 65Hz / PF > 0.95	
Maximum continuous charging current⁴⁾ (Secondary output)		60A	35A
Standard charge voltage (bulk / float @ 25°C)		14.3Vdc / 13.3Vdc (programmable)	28.6Vdc / 26.6Vdc (programmable)
Charge algorithm		IUoUp, intelligent 4-stage, temperature compensated (programmable)	
AC Transfer switch			
Maximum continuous current		16Arms	
Transfer time (typical)		0ms (inverter → mains) / < 5ms (mains → inverter)	
General			
Communication port		TBSLink	
Protected against		high/low battery voltage, high temperature, overload, short circuit, high ripple voltage and low AC input voltage	
Indications		Power on, output power bar, error and ASB mode	
DC input connections		Two wires, length 1.5 meters, 35 mm ²	
AC output connections		Screw terminals	
Enclosure body size (height x width x depth)		351 x 210 x 114 mm	
Total weight		10.7 kg	
Protection class / operating temp. / storage temp.		IP21 / -20°C to + 50°C / -40°C to + 80°C (humidity max. 95% non condensing)	
Standards		CE marked meeting EMC directive 2014/30/EU and LVD 2014/35/EU complying with EN60335-1, EN60335-2-29 and RoHS 2011/65/EU	

Note: the given specifications are subject to change without notice.

- ¹⁾ Measured with resistive load at 25°C ambient. Power ratings are subject to a tolerance of 10% and are decreasing as temperature rises with a rate of approx. 1.2%/°C starting from 25°C
- ²⁾ Undervoltage limit is dynamic. This limit decreases with increasing load to compensate the voltage drop across cables and connections
- ³⁾ Measured at nominal input voltage and 25°C
- ⁴⁾ At high ambient temperatures, maximum output current shall be reduced automatically

Accessories

- Universal Remote Control with LCD
- Basic Remote Control with LEDs
- TBSLink communication kit including software
- Alarm output expander



Basic Combi Remote Control, art # 5095210



Universal Remote Control (Powersine Combi), art # 5095500



TBSLink to USB Interface Kit, art # 5092120
(Includes TBS Dashboard for monitoring and configuring the Powersine Combi inverter/chargers)

Powersine Combi

2000-12-80, 2500-24-50,
3000-12-120 and 3500-24-70

INVERTER / CHARGER

DC to AC true sinewave inverter
programmable automatic battery charger
automatic transfer switch



Description

The PSC2000-12-80 up to PSC3500- 24-70 Powersine Combi products are based on the latest generation Powersine inverter engine, which guarantees very reliable operation and huge output power reserves.

The Powersine Combi also features a powerful intelligent battery charger and an ultra fast AC transfer switch. All this is combined in a very compact, yet installer friendly unit.

The Powersine Combi offers many innovative features like AC Input Power Boost, which temporarily assists weak AC input sources when more power is needed than available. Another feature is AC Input Current Limit, which limits the maximum current consumed from the AC input source by the Powersine Combi in charger mode.

Furthermore, the Powersine Combi is equipped with a TBSLink port to connect to a remote control or to a Windows device running TBS Dashboard, for easy step by step configuration and readout.

Also available are two fully configurable 16A alarm relay

outputs and two unique trigger inputs, that can convert external trigger commands into a number of Powersine Combi status changes.

Each Powersine Combi comes standard with a mounting kit, a temperature sensor, crimp terminals for DC cables and clear manuals.

Features

- True sinewave AC output
- Robust industrial design
- High surge power output
- Powerful 4-stage two output battery charger
- Power factor corrected AC input
- Fast 30A AC transfer switch
- AC Input Power Boost
- AC Input Current Limit
- Protected against high/low battery voltage, high temperature, overload, short circuit, high ripple voltage and low AC input voltage
- Automatic Standby function to reduce no-load
- power consumption
- Variable speed fan for silent operation
- Remote on/off capability
- Two programmable 250V/16A relays
- Two trigger inputs
- Remote control capability via TBSLink
- Easy to access connection bay for installing AC-, DC and control wiring
- CE certified
- 24 month warranty 24 month warranty

Applications

- Recreational vehicles
- Marine applications
- Solar power systems
- Industrial systems
- Mobile entertainment systems
- Service vehicles
- Remote homes



Accessories

- Universal Remote Control with LCD
- Basic Remote Control with LEDs

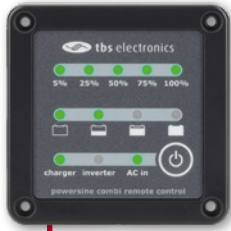

Basic Combi Remote Control, art # 5095210

- TBSLink communication kit including software
- Alarm output expander



Universal Remote Control (Powersine Combi), art # 5095500

TBSLink to USB Interface Kit, art # 5092120
(Includes TBS Dashboard for monitoring and configuring the Powersine Combi inverter/chargers)



Technical specifications

Parameter		PSC2000-12-80 art # 5018100	PSC2500-24-50 art # 5018120	PSC3000-12-120 art # 5018300	PSC3500-24-70 art # 5018320
Inverter stage					
Output power¹⁾	P _{nom}	1800W	2000W	2600W	2800W
	P _{10minutes}	2100W	2500W	3200W	3800W
	P _{surge}	4000W	5500W	5000W	6500W
Output voltage		230Vac ± 2%			
Output frequency		50Hz or 60Hz ± 0.05% (selectable)			
Output waveform		True sinewave (THD < 5% ¹⁾ @ P _{nom})			
Input voltage	Nominal	12Vdc	24Vdc	12Vdc	24Vdc
	Range	10.0 ²⁾ – 16.5Vdc	20.0 ²⁾ – 33Vdc	10.0 ²⁾ – 16.5Vdc	20.0 ²⁾ – 33.0Vdc
Maximum efficiency		92%	93%	92%	93%
No load power consumption³⁾ [ASB]		<19W [2.0W]	<20W [2.0W]	<19W [2.0W]	<20W [2.0W]
Charger stage					
AC input voltage		185 - 270Vac / 45 - 65Hz / PF > 0.95			
Maximum continuous charging current⁴⁾ (Secondary output)		80A (4A)	50A (4A)	120A (4A)	70A (4A)
Standard charge voltage (bulk / float @ 25°C)		14.3Vdc / 13.3Vdc	28.6Vdc / 26.6Vdc	14.3Vdc / 13.3Vdc	28.6Vdc / 26.6Vdc
Charge algorithm		IUoUp, intelligent 4-stage, temperature compensated (programmable)			
AC Transfer switch					
Maximum continuous current		30Arms			
Transfer time (typical)		0ms (inverter → mains) / < 5ms (mains → inverter)			
General					
Communication port		TBSLink			
Protected against		high/low battery voltage, high temperature, overload, short circuit, high ripple voltage and low AC input voltage			
Indications		Power on, output power bar, error and ASB mode			
DC input connections		M10 bolt terminals			
AC output connections		Screw terminals			
Enclosure body size (height x width x depth)		370 x 431 x 132 mm			
Total weight		18.5 kg	18.5 kg	19.0 kg	19.0 kg
Protection class/operating temp./storage temp.		IP21 / -20°C to + 50°C / -40°C to + 80°C (humidity max. 95% non condensing)			
Standards		CE certified (EMC Directives UNECE Regulation 10 and 2014/30/EU, Low voltage Directive 2014/35/EU, RoHS Directive 2011/65/EU)			

Note: the given specifications are subject to change without notice.

¹⁾ Measured with resistive load at 25°C ambient. Power ratings are subject to a tolerance of 10% and are decreasing as temperature rises with a rate of approx. 1.2%/°C starting from 25°C

²⁾ Undervoltage limit is dynamic. This limit decreases with increasing load to compensate the voltage drop across cables and connections

³⁾ Measured at nominal input voltage and 25°C

⁴⁾ At high ambient temperatures, maximum output current shall be reduced automatically

Expert Series high precision battery monitors

Complete battery status at a glance

Operating your battery bank without good metering is like running your car without any gauges, although possible to do, it's always better to know how much fuel is left in the tank. Defining the amount of energy available in a battery is a complex task and very different to simply checking the water or fuel level inside a tank.

Many different factors influence the actual battery capacity, including its age, the intensity of the loads connected to the battery and the battery temperature. Although a Volt meter can give a rough indication of the battery's state of charge under some conditions, for more accurate and reliable status information an Expert battery monitor is the best choice.

More than just a State of Charge readout

Offering an accurate State of Charge readout is the primary function of an Expert battery monitor. But much more functionality is added to these products. All models are also showing battery voltage, charge-/discharge current, Amphours and the voltage plus rough State of Charge indication of a second battery bank.

The Expert Pro also adds a time remaining and a battery temperature readout to this. While the Expert Modular goes even further by adding a readout for power, operating/maintenance hours and the status of a third battery bank.

All Expert battery monitors are equipped with a potential free alarm contact, that can be configured to activate when a certain battery State of Charge or voltage level has been reached. This can be used to for example start a generator for charging the battery when a critical level has been reached.

The Pro and Modular models offer even more features which are explained on the next few pages. Each Expert model has specific properties, which enables us to offer a proper solution for a wide range of applications.



Monitoring Lithium batteries

Although in some lead-acid battery applications people are still relying on a Volt meter for a rough battery status readout, this option is no longer valid when implementing Lithium batteries. A Lithium battery is known for its very flat voltage response against State of Charge. Therefore, monitoring such a battery only on voltage is not possible anymore. All Expert battery monitors are fully compatible with Lithium batteries and are being widely used in Lithium based applications for many years already.

Passive and Active shunts

The Expert Lite, Pro and Pro-hv are connected to a passive shunt for current measurement. This is a cost effective solution with a small footprint. It also offers the possibility to exchange the standard supplied 500Amp shunt with a smaller or larger capacity one.

The Expert Modular however, contains an active shunt. Since all measurement and control electronics are build inside the shunt, it will result in the highest accuracy. Information to the display unit is transferred over a digital cable connection instead of an analogue one, making it even more robust in noisy industrial environments. Additionally, the active shunt can also run in a stand-alone setup without display. This is an interesting option for systems that only require the battery data processed inside the shunt.

Expert

Lite, Pro and Pro-hv



Description

Defining the amount of energy available in a battery is a complex task since battery age, discharge current and temperature all influence the actual battery capacity. All Expert battery monitors are equipped with high performance measuring circuits, which in combination with complex software algorithms, are used to exactly determine the remaining capacity of your battery.

In general, our entry model Expert Lite is focussed on a simple readout by utilizing most of the display area to show a large battery state of charge bar graph. Although it still offers great accuracy, the feature set is more limited compared to the higher end Expert Pro and Expert Modular. This makes the Expert Lite the ideal instrument for less technical end-users and relatively simple battery installations.

The Expert Pro is physically identical to the Expert Lite, but offers a larger amount of features and a more detailed display. Most of the additional features are very useful when installing the battery monitor in more advanced battery systems. Programming voltage or state of charge alarms more extensively, recalling certain history events or the capability to extend the input voltage range with an

optional voltage prescaler, are some of the additional features offered by the Expert Pro. The Expert Pro-hv is identical to the Expert Pro, with the exception of the input voltage range which is extended up to 70Vdc. All models are equipped with an internal programmable alarm relay, to run a generator when needed or to turn off devices when the battery voltage exceeds programmable boundaries. A passive 500A shunt is standard included in the package.

Features

- Read your battery bank like a fuel gauge
- Provides critical information about the status of your battery bank
- Displays voltage, current, consumed amhours, remaining battery capacity and time remaining (Pro only)
- Two battery inputs
- Large display with backlight
- Quick nut mounting construction
- Programmable alarm relay
- Shunt selection capability, enables flexible system integration
- Communication/expansion port (Pro only)
- History event storage (Pro only)
- Splash proof frontpanel

- 500 Amp shunt included
- CE and e-mark certified
- 24 month warranty

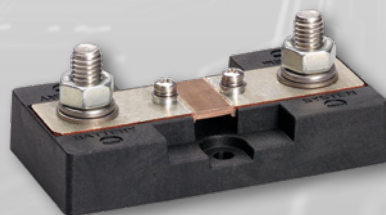

Applications

- Electric Vehicles
- Marine applications
- Solar power systems
- Industrial systems
- Electric forklifts
- Mobile entertainment systems
- Service vehicles
- Recreational vehicles
- Remote homes

Standard included 500A shunt



Expert Lite available screens



State of Charge

Shows the exact state of charge of your battery in percent. This is the most essential reading, as it represents the true status of your battery, being calculated by the advanced Expert algorithms.



Volts

This is a simple reading to show the battery voltage under load, idle or charge. It is a quick reflection of the state of your battery, but does not really let you know the true battery condition.



Amps

The Amp reading is an excellent way to check the load intensity on your battery. It allows you to minimize the current draw of non essential loads, or to check if your battery is actually being charged.



Amp hours

Shows the accumulated amp-hours consumed from the battery over a set period of time. This value will start from zero again, after the battery has been fully charged.

Expert Pro / Pro-hv available screens



State of Charge

Shows the exact state of charge of your battery in percent. This is the most essential reading, as it represents the true status of your battery, being calculated by the advanced Expert algorithms.



Volts

This is a simple reading to show the battery voltage under load, idle or charge. It is a quick reflection of the state of your battery, but does not really let you know the true battery condition.



Amps

The Amp reading is an excellent way to check the load intensity on your battery. It allows you to minimize the current draw of non essential loads, or to check if your battery is actually being charged.



Amp hours

Shows the accumulated amp-hours consumed from the battery over a set period of time. This value will start from zero again, after the battery has been fully charged.



Time Remaining

Smart software calculates the time remaining in your battery based upon the current load. This can be used as a good guide to when your battery has reached the discharge floor and must be recharged.



Temperature

This reading is only available when an external temperature sensor is connected to the battery monitor and shows you the actual battery temperature.

Expert Lite, Pro and Pro-hv

75.9 % MAIN

Accessories

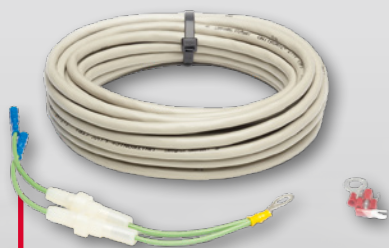

Professional Connection Kit 10m

art # 5055440

The Expert professional connection kit makes life easier during installation of your battery monitor. It contains all necessary items for a professional and safe connection of the Expert battery monitor to your battery and shunt.



Temperature Sensor Kit 3m (Pro/Pro-hv only)

art # 5055310

By connecting the temperature sensor kit to your Expert Pro or Expert Modular, the exact temperature of your battery can be determined, resulting in even more precise battery monitoring. Also available in 10m length.



USB Communication Kit (Pro/Pro-hv only)

art # 5092100

This kit enables you to control, readout and configure the Expert Pro from your Windows PC. Another possibility is to use the PC as a datalogger to record all measured parameters for further analysis.



RS-232 Communication Kit (Pro/Pro-hv only)

art # 5055200

This kit enables you to control, readout and configure the Expert Pro from your Windows PC. Another possibility is to use the PC as a datalogger to record all measured parameters for further analysis.



1:5 Active Prescaler Kit (Pro only)

art # 5055511

The Expert Pro 1:5 Active voltage prescaler kit, extends the input voltage range of the expert pro to enable implementation in 48 VDC up to 120 VDC battery systems (maximum input voltage is 175VDC).

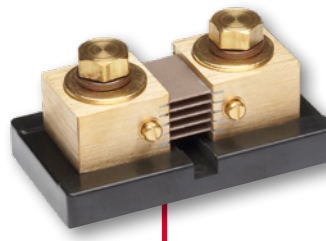

1200A/50mV Shunt Kit (Pro/Pro-hv only)

art # 5055180

The Expert pro 1200A/50mV Shunt kit, can be used in applications where the battery current would exceed the maximum ratings of the standard supplied 500A shunt.

Technical specifications

Parameter	Expert Lite art # 5055010	Expert Pro art # 5055030	Expert Pro-hv art # 5055040
Supply voltage range	9..35Vdc	9..35Vdc	14..70Vdc
Supply current ¹⁾	7mA @Vin=24Vdc 9mA @Vin=12Vdc	7mA @Vin=24Vdc 9mA @Vin=12Vdc	5mA @Vin=48Vdc 6mA @Vin=36Vdc
Input voltage range (auxiliary battery)	2..35Vdc	2..35Vdc	2..35Vdc
Input voltage range (main battery)	0..35Vdc	0..35Vdc	0..70Vdc
Input current range ²⁾	-999..+999A		-9999..+9999A
Battery capacity range	20..999Ah		20..9990Ah
Operating temperature range		-20..+50°C	
Storage temperature range		-30..+70°C	
Readout resolution:			
Voltage	± 0.1Vdc (0..35V)	± 0.01Vdc (0..35V)	± 0.01Vdc (0..70V)
Current	± 0.1A (0..100A)		± 0.1A (0..200A)
Current	± 1A (100..999A)		± 1A (200..9999A)
Amphours	± 0.1Ah (0..100Ah)		± 0.1Ah (0..200Ah)
Amphours	± 1Ah (100..999Ah)		± 1Ah (200..9990Ah)
State-of-charge	± 0.1% (0..100%)		± 0.1% (0..100%)
Time remaining	X		± 1minute (0..24hrs)
Time remaining	X		± 1hr (24..240hrs)
Temperature	X		± 0.5°C (-20..+50°C) ³⁾
Voltage measurement accuracy		± 0.5%	
Current measurement accuracy		± 0.8%	
General feature comparison:			
Supported battery voltages	12V/24V	12V/24V	36V/48V
Advanced battery modelling engine	•	•	•
Lithium compatible	•	•	•
State of Charge bar	•	•	•
Alarm relay	•	•	•
Two battery inputs	•	•	•
Time remaining readout	X	•	•
History event storage	X	•	•
Communication port	X	•	•
Temperature sensor input	X	•	•
Meter dimensions	Ø 64 mm (front diameter) / Ø 52 mm (body diameter) / 79 mm (depth)		
Meter weight	95 gr		
Shunt dimensions (length x width x height)	87 x 45 x 35 mm		
Shunt weight	145 gr		
Protection class	IP20 (front panel only IP65)		
Standards	CE marked meeting EMC directive 2014/30/EU and LVD 2014/35/EU complying with EN60335-1, RoHS 2011/65/EU and e4-95/54/EC		

Note: the given specifications are subject to change without notice.

¹⁾ Measured with backlight and alarm relay turned off

²⁾ Depends on selected shunt. With standard delivered 500A/50mV shunt (350A continuous), the range is limited to -600..+600A

³⁾ Only available when optional temperature sensor is connected

Expert Modular



Description

Defining the amount of energy available in a battery is a complex task since battery age, discharge current and temperature all influence the actual battery capacity. All Expert battery monitors are equipped with high performance measuring circuits, which in combination with complex software algorithms, are used to exactly determine the remaining capacity of your battery.

The Expert Modular is our latest generation, highly advanced battery monitor. It consists of an intelligent shunt and a remote control and display unit. The shunt has a Grid Optimized footprint for perfect integration with our DC Modular products. This advanced battery monitor not only shows the true state of charge of your battery system. It also offers a large amount of additional features to optimally supervise your battery system and control external equipment.

The Expert Modular is compatible with lead based and Lithium batteries (LiFePO4). This battery monitor can monitor up to three battery banks. The inputs for battery bank 2 and 3 can also be configured for other purposes, like midpoint voltage measurement, keyswitch input, setup lock or backlight control. The Expert Modular can measure DC currents up to 600Amps (500Amp continuous) and voltages up to 70Vdc. So any lead- or lithium based battery bank from 12V up to 48V can be monitored.

The installation time is minimal, requiring only one supply wire to the intelligent shunt base and a single 'QuickLink' cable between the shunt base and the control/display unit (CDU).

Additionally, the battery minus cable must be interrupted in order to insert the shunt into the high current circuit. The fused supply wire and the QuickLink cable are both included in the package, avoiding the need for a separate connection kit.

Features

- Read your battery bank like a fuel gauge
- Provides critical information about the status of your battery bank
- Very simple 'plug and play' installation
- Displays voltage, current, consumed amp-hours, remaining battery capacity, time remaining and power
- Extensive alarm programming capability
- Three battery inputs
- Large display with backlight
- Very small installation depth of display unit
- Programmable alarm relay
- Perfect integration with TBS DC Modular products
- QuickLink communication port
- History event storage
- Active shunt supports two display units or can also run stand alone
- Splash proof front panel of display unit
- CE and automotive certified (EN50498)
- 24 month warranty

Applications

- Electric Vehicles
- Marine applications
- Solar power systems
- Industrial systems
- Electric forklifts
- Mobile entertainment systems
- Service vehicles
- Recreational vehicles
- Remote sites



Standard included active 600A shunt



Expert Modular highlights

Special fiber reinforced base material offers excellent high temperature properties, good chemical resistance and high strength.

Voltage sense input for (main) battery bank 1. Also positive supply input for Expert Modular.

Voltage sense inputs for battery banks 2 and 3. Or assignable to other functions.

Potential free 5A/30Vdc (1A/70Vdc) programmable alarm relay contact to control external equipment.

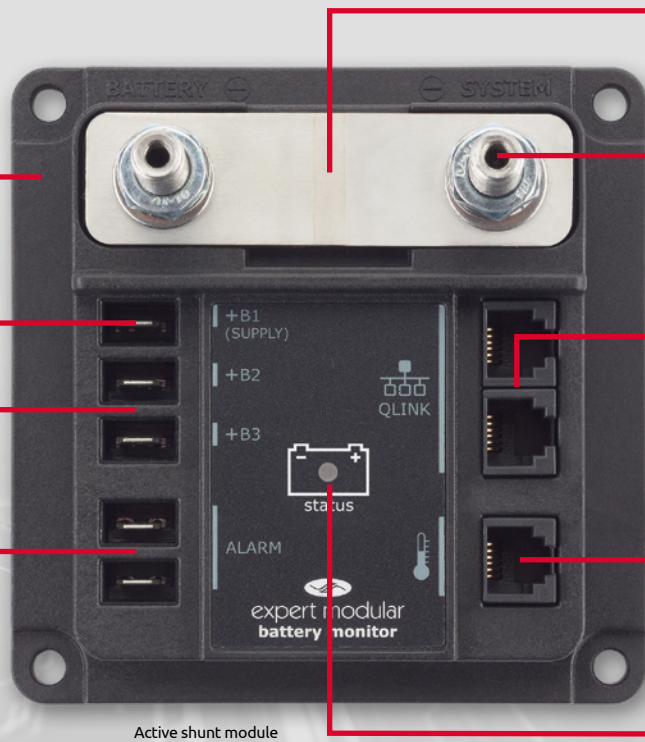

Ultra low loss custom made shunt module can handle 500A continuously.

Stainless steel studs, nuts and washers for optimal corrosion resistance.

Dual QuickLink port for connection to the Control & Display Unit or other accessories.

Input port for optional battery temperature sensor.

Multi purpose indicator provides status, error and battery state of charge information (3 colours).

Active shunt module

Large circular bar graph provides a clear battery state of charge indication. Smart display animations indicate whether the battery is being charged or discharged and by which intensity.

Simple three button interface allows easy parameter readout selection in normal operating mode and intuitive navigation through the setup menus.

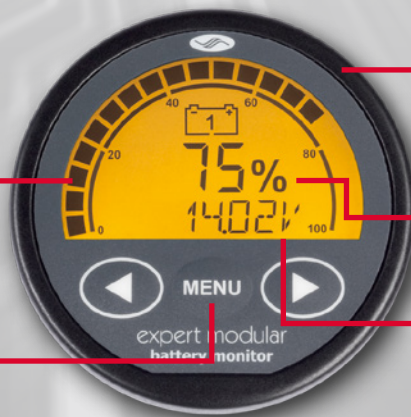

Compact round Control & Display Unit with splash proof front panel, large backlit display and only 36 mm installation depth.

Permanent large digit battery state of charge (%) indicator.

Second parameter row allows an additional parameter to be shown along with state of charge (%). During setup, this row will also show a clear textual explanation of each function.

Control & Display Unit

Expert Modular readout examples



Standard view The image above shows the normal operating mode with the second parameter row disabled. This results in a clean display area that only shows the battery state of charge (%) and the bar graph. A perfect mode for less technical end users.

Second parameter row

By enabling the second parameter row, the user can scroll through the following battery parameters: Volt, Amp, Ah, time remaining, temperature and Watts. The second parameter row can be set to automatically hide after a while, or to stay present permanently.



Easier setup During function setup, status or history readout, each parameter is clearly explained using scrolling text in the display. This will make it a lot easier to browse through the Expert Modular menu, without having to consult a list of parameter numbers.

Alarm indications When an alarm is activated (for example due to a low battery state of charge), the alarm bell icon will be lit and an explanation about the type of alarm will scroll through the display. An audible alarm can be enabled as well for additional attention.



Accessories



QuickLink to USB Communication Kit

art # 5092130

This kit enables you to control, readout and configure the Expert Modular from your Windows PC. Another possibility is to use the PC as a datalogger to record all measured parameters for further analysis.



QuickLink to RS-232 Communication Kit

art # 5092030

This kit enables you to control, readout and configure the Expert Modular from your Windows PC. Another possibility is to use the PC as a datalogger to record all measured parameters for further analysis.



QuickLink to Bluetooth Communication Kit

art # 5092230

This kit enables you to control, readout and configure the Expert Modular from an iOS or Android based mobile phone via Bluetooth. The Dashboard Mobile app is available in the Apple App Store and Google Play.



QuickLink Alarm Output Expander Kit

art # 5093120

This kit adds two additional alarm relays to the Expert Modular and can be used in case a system requires each alarm type to be assigned to a separate relay.



QuickLink to NMEA2000 Communication Kit

art #5092530

This kit enables you to readout the Expert Modular battery monitor through an NMEA2000 network and creates the possibility to show extensive battery bank data on any NMEA2000 compatible display.



Temperature Sensor Kit 3 m

art # 5055310

By connecting the temperature sensor kit to your Expert Modular, the exact temperature of your battery can be determined, resulting in even more precise battery monitoring. Also available in 10 m length.

Wiring diagram

Example diagram of a single battery setup. Notice the small amount of cables that are needed to get the Expert Modular up and running. The supply and CDU cables are both included. Also included but not shown in this picture are rubber caps to cover unused I/O ports against pollution.

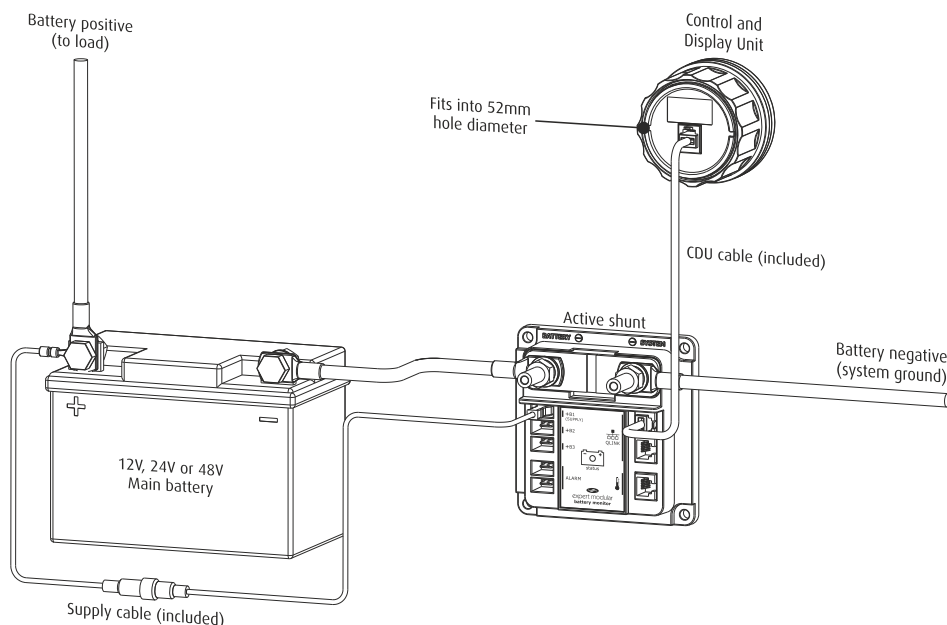

Technical specifications

Parameter	Expert Modular art # 5056030
Supply voltage range	7..70Vdc
Supply current (@ 12V/ 24V/48V)	10mA / 6mA / 5mA
Input voltage range main battery (+B1)	7..70Vdc ¹⁾
Input voltage range second and third battery (+B2, +B3)	1..70Vdc
Input current range	-600..+600A ²⁾
Battery capacity range	10..10000Ah
Operating temperature range	-20..+50°C
Storage temperature range	-30..+70°C
Readout resolution:	
Voltage (0..70V)	± 0.01Vdc
Current (0..10A)	± 0.01A
Current (10..100A)	± 0.1A
Current (100..600A)	± 1A
Amphours (0..10000Ah)	± 0.01Ah - 10Ah (variable)
Power (0..42kW)	± 0.01W - 1kW (variable)
State-of-charge (0..24hrs)	± 1%
Time remaining (0..24hrs)	± 1 min
Time remaining (24..240hrs)	± 1 hr
Temperature (-20°C..+50°C)	± 0.5°C
Maintenance hours (0..100000hrs)	± 1 hr
Voltage measurement accuracy	± 0.3%
Current measurement accuracy	± 0.4%
Display unit dimensions	Ø64 mm (front diameter) / Ø51.5 mm (body diameter) / 36 mm (depth)
Display unit weight	70 gr
Shunt dimensions (length x width x height)	100 x 100 x 64.5 mm
Shunt weight	260 gr
Protection class (Display + Shunt)	IP20 (display front panel only IP65)
Standards	CE certified meeting EMC Directive 2014/30/EU, LVD 2014/35/EU complying with EN60335-1, EN50498 Automotive EMC, RoHS 2011/65/EU

¹⁾ When input +B1 is only used for supply and +B2 for main battery voltage measurement, the input voltage range for the main battery is 1..70Vdc

²⁾ +/- 600A is the maximum rating for 20 minutes. The continuous input current range is +/- 500A

Note: the given specifications are subject to change without notice.



The Expert Modular active shunt base has a Grid Optimized footprint. This enables perfect system integration with busbars and fuseholders from the TBS DC Modular product lineup. The picture on the left shows a nice solution to avoid stacking all battery negative return cables on the single "System side" stud of the shunt.



DC Modular high current busbars, fuseholders and contactors



Modular DC power protection and distribution solutions



Due to the ever increasing complexity of electrical DC systems onboard of boats, vehicles or in stationary applications, there is a growing need for a uniform set of products that significantly improves the installation time and flexibility. The TBS DC Modular product range offers a perfect solution for this. It contains a wide range of high current busbars, fuseholders, contactors and interconnection materials. Compared to more traditional and often incompatible DC distribution products, the DC Modular system offers many innovative features.

Create space saving arrangements of different DC Modular products



All DC Modular products carrying the Grid Optimized Footprint logo, are easy to cluster along with each other. This results in a considerable reduction of the mounting footprint, offering greater flexibility to installers and allowing installation in tight spaces.

The common interconnection height enables quick and easy combining of multiple products using optional link plates. Besides reducing the installation time by avoiding the use of assembled interconnection cables, it will also increase the safety and efficiency of the high current link.

Only the best materials



All DC Modular products are equipped with stainless steel studs, washers and nuts for optimal corrosion resistance. Tin plated high purity copper busses provide maximum conductivity, reducing heat and improving efficiency. The base material used for the DC Modular products, is made from a special fiber reinforced compound. This material offers excellent high temperature properties, good chemical resistance and high strength. This focus on the highest quality materials, ensures long lifetimes in harsh environments. All DC Modular products are designed and assembled in The Netherlands.





Compatibility with the Expert Modular

The DC Modular product range is also a perfect companion for the TBS Expert Modular battery monitor. The footprint of this advanced battery monitor fits perfectly into the DC Modular grid, allowing optimal integration with the busbars and fuse holders.

Switching high current loads with intelligent contactors

The DC Modular lineup also contains our Remote Battery Switch (RBS) and Battery Protect Relay (TBP). These are intelligently controlled 500A contactors that can switch voltages up to 60Vdc. Due to the magnetically latching construction, these contactors draw no current from the battery in between switching actions. This makes it an ideal product to use as a low voltage disconnection relay for batteries. Local control by switches on top of the device, or wired remote control by a panel switch, battery monitor or BMS provides great system integration possibilities. Compared to the RBS, the TBP adds built in battery protection and a smart 'Override' mode for jump starting.

Professional fuseholders deserve safe high quality fuses

Too often we have seen things go bad due to the use of cheap 'no-name' fuses. Our own tests have demonstrated that a reasonable amount of low cost fuses on the market today, are not performing according to their specifications. This can vary from great deviations between the specified and the actual melting currents versus time, up to fuse housings almost catching fire when exposed to continuous rated current levels. The use of such fuses must obviously be avoided, since these are installed to protect against fire or equipment damage in the first place and not to become a safety hazard itself. For these reasons, TBS is an authorized dealer of A-brands Littelfuse and SIBA. We stock a wide range of values from the MEGA, ANL and Class-T fuse families. This enables us to offer our customers a reliable and safe circuit protection package.

DC Modular

Premium quality Busbars,
Fuseholders and Contactors



DC Modular highlights

Easy in-system connection access due to top locked covers by convenient thumb screws.

Special fiber reinforced base material offers excellent high temperature properties, good chemical resistance and high strength.

Smart terminal design allows dual mirrored cable lug connections.

Top sides of transparent covers are equipped with recessed locations to properly add custom labels.

Robust transparent covers with breakouts to allow wire access from any direction.

Tin plated high purity copper busses provide maximum conductivity, reducing heat and improving efficiency.

Stainless steel studs, nuts and washers for optimal corrosion resistance.

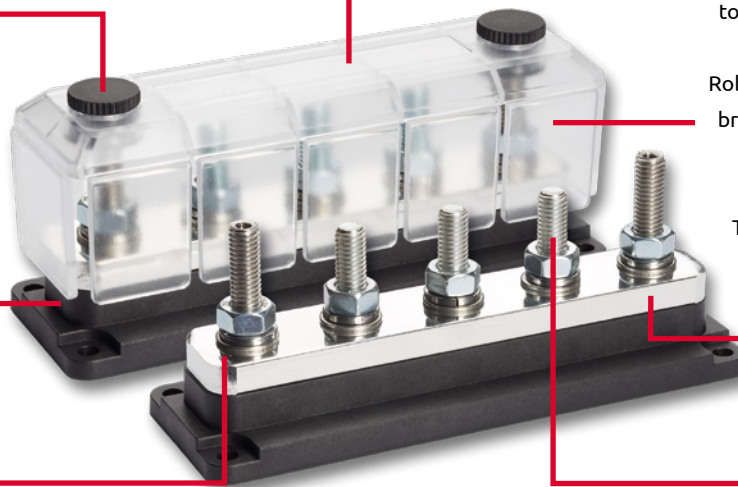

Transparent polycarbonate cover with break-out side skirts at each side, for easy cable entry.



The optional adapter plate allows a mixture of high- and low power cables to be connected to the same stud.

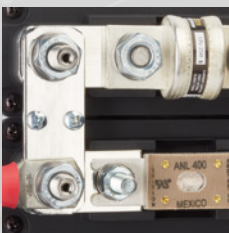

Multiple fuseholders and busbars can be connected to each other with the optional link plates.

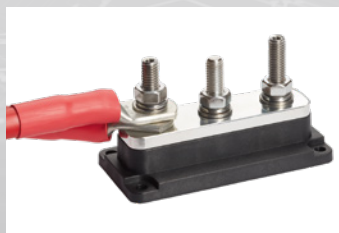

Smart terminal design allows dual mirrored cable lug connections.



Application example of a compact DC Modular cluster containing the Expert Modular active shunt, a 3-Stub Busbar and two Fuseholders.



High current Busbars

Description

The DC Modular high current busbars are used to distribute high DC currents to a number of connected cables, or other DC Modular family members.

The solid and compact design, as well as the possibility to link up multiple busbars on a fixed grid, make these products the best choice for all professional DC power systems. The high current busbars are available with M8 or M10 stud sizes.

Features

- Stainless steel studs, nuts and washers for optimal corrosion resistance
- Tin plated high purity copper busses provide maximum conductivity, reducing heat and improving efficiency
- Special fiber reinforced base material offers excellent high temperature properties, good chemical resistance and high strength
- Unique grid optimized footprints allow space saving arrangements of multiple products
- Common interconnection heights for easy combining of multiple products using link plates
- Robust transparent covers with breakouts to allow wire access from any direction
- Smart terminal design allows dual mirrored cable lug connections
- Easy in-system connection access due to top locked covers

3 stud Busbar



Model	Art #	Grid size	Max. Current	Max. Voltage ¹⁾	Stud size	Dimensions
DCM 3xM8 Busbar	5073160	1 x 2	600A	60V	M8	100.0 x 50.0 x 64.5 mm
DCM 3xM10 Busbar	5073180	1 x 2	600A	60V	M10	100.0 x 50.0 x 64.5 mm

¹⁾ Higher voltages may require additional safety measures

5 stud Busbar



Model	Art #	Grid size	Max. Current	Max. Voltage ¹⁾	Stud size	Dimensions
DCM 5xM8 Busbar	5075160	1 x 3	600A	60V	M8	150.0 x 50.0 x 64.5 mm
DCM 5xM10 Busbar	5075180	1 x 3	600A	60V	M10	150.0 x 50.0 x 64.5 mm

¹⁾ Higher voltages may require additional safety measures

DC Modular

Insulated Studs

Description

The DC Modular single and dual insulated studs are ideal parts to extend cables, add power taps or form termination end-points.

The solid and compact design, as well as the possibility to link these up with other DC Modular family members, make these products the best choice for all professional DC power systems. The insulated studs are available with M8 or M10 stud sizes.

Features

- Stainless steel studs, nuts and washers for optimal corrosion resistance
- Special fiber reinforced base material offers excellent high temperature properties, good chemical resistance and high strength
- Unique grid optimized footprints allow space saving arrangements of multiple products
- Common interconnection heights for easy combining of multiple products using link plates
- Robust transparent covers with breakouts to allow wire access from any direction
- Top sides of transparent covers are equipped with recessed locations to properly add custom labels (Dual insulated stud only)
- Smart terminal design allows dual mirrored cable lug connections
- Easy in-system connection access due to top locked covers

Single Insulated Stud



Model	Art #	Grid size	Maximum Current	Max. Voltage ¹⁾	Stud size	Dimensions
DCM 1xM8 Single Stud	5071160	1 x 1	N/A	60V	M8	50.0 x 50.0 x 64.5 mm
DCM 1xM10 Single Stud	5071180	1 x 1	N/A	60V	M10	50.0 x 50.0 x 64.5 mm

¹⁾ Higher voltages may require additional safety measures

Dual Insulated Stud



Model	Art #	Grid size	Maximum Current	Max. Voltage ¹⁾	Stud size	Dimensions
DCM 2xM8 Dual Stud	5072160	1 x 1.5	N/A	60V	M8	75.0 x 50.0 x 64.5 mm
DCM 2xM10 Dual Stud	5072180	1 x 1.5	N/A	60V	M10	75.0 x 50.0 x 64.5 mm

¹⁾ Higher voltages may require additional safety measures



Fuseholders

Description

A wide range of fuseholders are available in the DC Modular lineup, covering fuse Amp ratings from 35A up to 600A.

Fuseholders are offered for the Mega®, ANL and Class-T type of fuses, providing solutions for a wide range of applications. The solid and compact design, as well as the possibility to link up multiple fuseholders on a fixed grid, make these products the best choice for all professional DC power systems.

Features

- Stainless steel studs, nuts and washers for optimal corrosion resistance
- Tin plated high purity copper busses provide maximum conductivity, reducing heat and improving efficiency
- Special fiber reinforced base material offers excellent high temperature properties, good chemical resistance and high strength
- Unique grid optimized footprints allow space saving arrangements of multiple products
- Common interconnection heights for easy combining of multiple products using link plates (except Mega and ANL (300A) fuseholders)
- Robust transparent covers with breakouts to allow wire access from any direction
- Smart terminal design allows dual mirrored cable lug connections
- Easy in-system connection access due to top locked covers (except Mega and ANL (300A) fuseholders)

Mega Fuseholder (300A)



Model	Art #	Grid size	Fuse range ¹⁾	Max. Voltage ²⁾	Stud size	Dimensions
DCM Mega Fuseholder	5073300	1 x 1.78 ³⁾	40 .. 300A	60V	M8	89.0 x 50.0 x 53.0 mm

¹⁾ Compatible with Littelfuse® 'Mega' and Cooper Bussmann® 'AMG' fuses

²⁾ Higher voltages may require additional safety measures

³⁾ The Mega fuseholder 300A is optimized for stand-alone use and is not compatible with link- and adapter plates

Mega Fuseholder (500A)

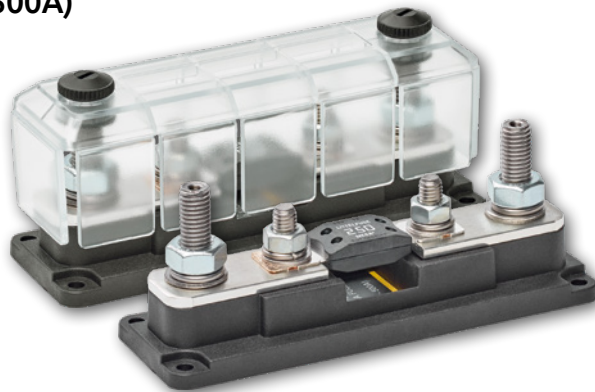

Model	Art #	Grid size	Fuse range ¹⁾	Max. Voltage ²⁾	Stud size	Dimensions
DCM Mega Fuseholder (500A)	5073350	1 x 3	40 .. 500A	60V	M8	150.0 x 50.0 x 64.5 mm

¹⁾ Compatible with Littelfuse® 'Mega' and Cooper Bussmann® 'AMG' fuses

²⁾ Higher voltages may require additional safety measures

DC Modular

ANL Fuseholder (300A)



Model	Art #	Grid size	Fuse range ¹⁾	Max. Voltage ²⁾	Stud size	Dimensions
DCM ANL Fuseholder (300A) M8	5073500	1 x 2 ³⁾	35 .. 300A	60V	M8	100.0 x 50.0 x 53.0 mm
DCM ANL Fuseholder (300A) M10	5073510	1 x 2 ³⁾	35 .. 300A	60V	M10	100.0 x 50.0 x 53.0 mm

¹⁾ M8 version compatible with Littelfuse® 'CNN' and 'CNL' plus Cooper Bussmann® 'ANL' and 'ANN' fuses

M10 version compatible with Littelfuse® '157.57' plus SIBA® '90 058 05' fuses

²⁾ Higher voltages may require additional safety measures

³⁾ The ANL fuseholder has a grid optimized footprint but is not compatible with link- and adapter plates

ANL Fuseholder (600A)

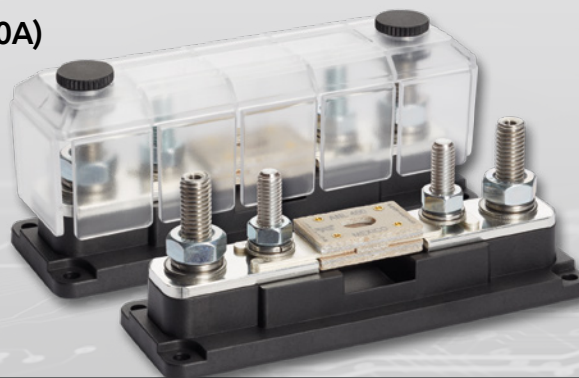

Model	Art #	Grid size	Fuse range ¹⁾	Max. Voltage ²⁾	Stud size	Dimensions
DCM ANL Fuseholder (600A) M8	5073550	1 x 3	35 .. 600A	60V	M8	150.0 x 50.0 x 64.5 mm
DCM ANL Fuseholder (600A) M10	5073560	1 x 3	35 .. 600A	60V	M10	150.0 x 50.0 x 64.5 mm

¹⁾ M8 version compatible with Littelfuse® 'CNN' and 'CNL' plus Cooper Bussmann® 'ANL' and 'ANN' fuses

M10 version compatible with Littelfuse® '157.57' plus SIBA® '90 058 05' fuses

³⁾ Higher voltages may require additional safety measures

Class-T Fuseholder (225-400A)



Model	Art #	Grid size	Fuse range ¹⁾	Max. Voltage ²⁾	Stud size	Dimensions
DCM Class-T Fuseholder (400A)	5073850	1 x 3	225 .. 400A	60V	M10	150.0 x 50.0 x 64.5 mm

¹⁾ Compatible with Littelfuse® 'JLLN', Cooper Bussmann® / Edison® 'JJN' and 'TJN' and Mersen® 'A3T' fuses

²⁾ Higher voltages may require additional safety measures



Class-T Fuseholder (450-600A)



GRID OPTIMIZED FOOTPRINTS



Model	Art #	Grid size	Fuse range ¹⁾	Max. Voltage ²⁾	Stud size	Dimensions
DCM Class-T Fuseholder (600A)	5073880	1 x 3	450 .. 600A	60V	M10	150.0 x 50.0 x 64.5 mm

¹⁾ Compatible with Littelfuse® 'JLLN', Cooper Bussmann® / Edison® 'JJN' and 'TJN' and Mersen® 'A3T' fuses

²⁾ Higher voltages may require additional safety measures

Fuses

Description

In order to complement the high current fuseholders from our DC Modular lineup, we are able to supply the required fuses as well. TBS is a reseller of premium fuse brands Littelfuse and SIBA. For optimal safety, we always advise our customers to use fuses from well known brands. Please contact one of our sales engineers for further advise on which type of fuse to select for your application.

The tables below show the fuse values per type that we keep in stock as standard.



MEGA



ANL



Class-T

Value	Art #
40A / 32Vdc	5097319-2
60A / 32Vdc	5097323-2
80A / 32Vdc	5097327-2
100A / 32Vdc	5097331-2
125A / 32Vdc	5097334-2
150A / 32Vdc	5097337-2
175A / 32Vdc	5097340-2
200A / 32Vdc	5097343-2
250A / 32Vdc	5097349-2
300A / 32Vdc	5097355-2

Value	Art # (M8)	Art # (M10)
50A / 80Vdc	5097521-2	5097621-2
100A / 80Vdc	5097531-2	5097631-2
150A / 80Vdc	5097537-2	5097637-2
200A / 80Vdc	5097543-2	5097643-2
250A / 80Vdc	5097549-2	5097649-2
300A / 80Vdc	5097555-2	5097655-2
350A / 80Vdc	5097557-2	5097657-2
400A / 80Vdc	5097559-2	5097659-2
500A / 80Vdc	5097563-2	5097663-2
600A / 80Vdc	5097565-2	-

Value	Art #
225A / 125Vdc	5097846-1
300A / 125Vdc	5097855-1
400A / 125Vdc	5097859-1
450A / 125Vdc	5097861-1
600A / 125Vdc	5097865-1

Other fuse values on request

DC Modular

Remote Battery Switch / Battery Protect Relay



Description

The DC Modular Remote Battery Switch (RBS) and Battery Protect Relay (TBP) are smart high current magnetic latching contactors, that can handle continuous DC currents of up to 500Amps. The contactors can easily be installed in an engine room or battery compartment, while being controlled from a more convenient location by a small panel mounted switch. The RBS / TBP can however also be controlled by a battery monitor or managed lithium battery.

Besides controlling the contactors remotely, buttons positioned at the top also provide a way to open or close the main contact locally, as required by Marine Standards. A 5 wire interface cable is used to control the contactors externally. For optimal flexibility, these can be configured to accept two wire or single wire open and close commands. A wire for providing a contact status feedback signal is also available.

Status LEDs on top clearly indicate whether the main contact is opened or closed. These indicators also provide additional visual feedback like operating- and error modes.

A specially developed internal solenoid guarantees a powerful contact drive, even when supplied by deeply discharged batteries.

Both the RBS and the TBP can be used to switch battery loads, through local and/or external control. The TBP however, has a number of additional features. The most important one being built-in battery protection.

The TBP will automatically open the main contact once the battery voltage has dropped below a programmable low voltage level. When subsequently the battery voltage has risen above the programmable reconnect voltage, the main contact is closed again.

Another handy TBP feature is the Override mode. In situations where the TBP has opened the main contact due to a battery undervoltage, long-pressing the close button (local or external) will close the main contact for 1 minute. This allows the user to jumpstart a low battery system. When after this minute the battery voltage remains too low, the contact will open up again. But it remains closed when during the override time, a charger has been connected causing the battery voltage to recover.

Being a member of the DC Modular product line up, the RBS and TBP can be perfectly integrated into very compact DC distribution systems.

Features

- Electronically controlled magnetic latching contactor
- Extremely low power consumption (< 100µA)
- Up to 500Amp nominal current
- 60Vdc contact rating
- Local and external open / close control
- Visual status indicators

- Small footprint
- DC Modular grid compatible for compact and easy arrangements of multiple devices
- Selectable control modes
- Battery protection (TBP only)
- Override mode (TBP only)

Applications

- Battery management systems
- Marine applications
- Off grid solar power systems
- Battery load shedding applications
- Service vehicles
- Recreational vehicles
- Industrial systems



Parameter	DCM-RBS-12-500 (art # 5074510)	DCM-RBS-24-500 (art # 5074520)	DCM-RBS-48-350 (art # 5074540)	DCM-TBP-12-500 (art # 5074410)	DCM-TBP-24-500 (art # 5074420)	DCM-TBP-48-350 (art # 5074440)
Main contact circuit (electrical)						
Rated voltage	60Vdc					
Nominal current	500A					
Cranking current (1min.)	1000A					
Nominal make / break current	500A (0 - 34Vdc)		350A (35 - 60Vdc)			
Peak make / break current	1600A (0 - 34Vdc)		1200A (35 - 60Vdc)			
Control circuit (electrical)						
Coil / supply voltage (+Vdc)	7.5 - 17Vdc	15 - 34Vdc	34 - 68Vdc	7.5 - 17Vdc	15 - 34Vdc	34 - 68Vdc
Coil / supply current (idle state) ¹⁾	< 100uA					
Coil / supply current (state change) ¹⁾	< 6A	< 3A	< 1.5A	< 6A	< 3A	< 1.5A
Features						
Remote battery switch function	•	•	•	•	•	•
Battery protect function	x	x	x	•	•	•
Local open / close controls	•	•	•	•	•	•
External open / close control wires	•	•	•	•	•	•
Contact status indicators	•	•	•	•	•	•
Contact status feedback wire	•	•	•	•	•	•
Override mode ²⁾	x	x	x	•	•	•
Number of control modes	5	5	5	7	7	7
Programmable disconnect voltages	x	x	x	9.0 - 12.2Vdc	18.0 - 24.5Vdc	36.0 - 49.0Vdc
Programmable reconnect voltages	x	x	x	10.5 - 13.8Vdc	21.0 - 27.5Vdc	42.0 - 55.0Vdc
General						
Remote control	By control wires					
Local control ³⁾	Top side buttons (On/Standby, Close contact, Open contact)			Top side buttons (On/Standby, Close contact, Open contact, Override mode)		
Indicators	Top side LEDs for Contact open, Contact closed, Error and Setup					
Mechanical / Electrical life	100000 cycles / 10000 cycles					
Operating temperature range	-20..+60°C					
Connection stud size	M10					
DC Modular grid size	1 x 3					
Protection class	IP65					
Dimensions	150.0 x 50.0 x 94.0 mm					
Weight	800gr					
Standards	CE certified (EMC Directives UNECE Regulation 10 (only 12V and 24V models) and 2014/30/EU, Low voltage Directive 2014/35/EU, RoHS Directive 2011/65/EU and Ignition protection standard ISO 8846)					

Note: the given specifications are subject to change without notice.

¹⁾ Due to the magnetic latch construction, the DCM RBS and TBP draw virtually no current in the ON or OFF state. A current draw only exists shortly (500ms max) when changing the state of the contact.

²⁾ Override mode allows the contact to be temporarily closed, despite being automatically opened earlier due to a battery under voltage. This is intended for jumpstarting a low battery system.

³⁾ Using the top side buttons, one can manually override the switch state as commanded through the control wires. A dedicated 'On/Standby' button also allows the user to put the DCM RBS or TBP in a standby mode with open contact. In this mode any commands from the control wires and/or manual override buttons are ignored.



Accessories

Panel Switch Momentary SPDT + LED art# 5095000-1

With this optional panel switch you can send open and close commands to the RBS and TBP contactors from a convenient location. The integrated LED indicates when the contact is closed or when the contactor is running in a certain mode.

DC Modular

Accessories

Description

Due to the common interconnection heights, smart space saving arrangements of multiple DC Modular products can be made by linking these together using the optional Link Plates.

We have managed to offer only three Link Plate sizes to create all possible combinations. All Link Plates are compatible with M8 and M10 studs. Additionally, we have equipped some Link Plates with two M4 screws to provide convenient connection points for smaller cables.

For this purpose only, we are also offering an Adapter Plate which allows a mixture of high and low power cables to be connected to the same stud. The Adapter Plate can be used on M8 and M10 studs and offers four connection points for smaller cables.

Features

- Tin plated high purity copper busses provide maximum conductivity, reducing heat and improving efficiency
- Stainless steel M4 screws and washers provide convenient connection points for smaller cables
- Compatible with M8 and M10 studs

Link Plate 41 mm



Model ¹⁾	Art #	Max. Current ²⁾	Dimensions (L x W)	Accepts stud size
DCM Link Plate 41mm	5079062	600A	63.0 x 25.0 mm	M8 + M10

¹⁾ Not compatible with "Mega (300A)" and "ANL (300A)" fuseholders

²⁾ Current capacity can be doubled by stacking two Link Plates (after removal of M4 screws)

End to end linking

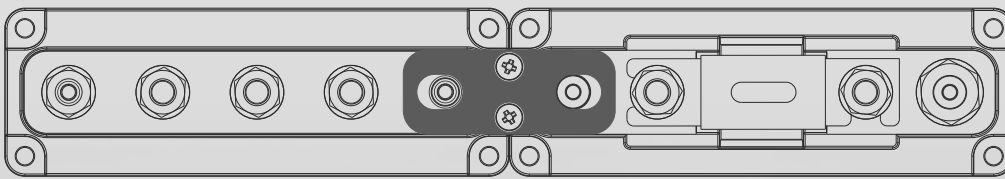

For linking to and from:

- DCM 2xM8/M10 Dual Stud
- DCM 3xM8/M10 Busbar
- DCM 5xM8/M10 Busbar
- DCM Mega Fuseholder (60V/500A)
- DCM ANL Fuseholder (60V/600A)
- DCM Class-T Fuseholder (60V/225-400A)
- DCM Class-T Fuseholder (60V/450-600A)
- DCM RBS / TBP

End to side linking

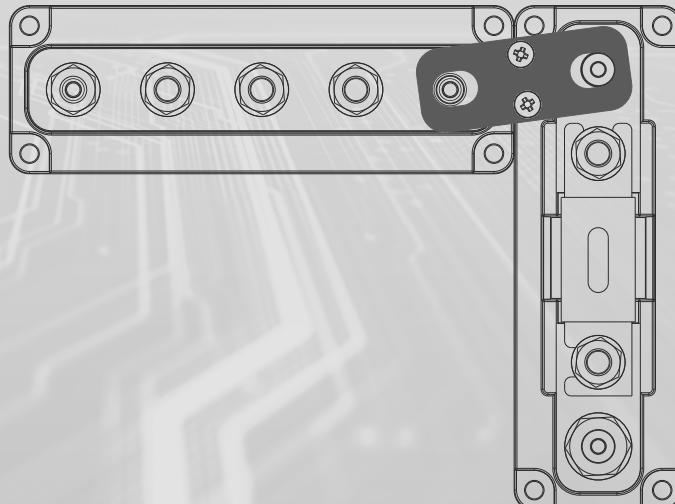

For linking to and from:

- DCM 2xM8/M10 Dual Stud
- DCM 3xM8/M10 Busbar
- DCM 5xM8/M10 Busbar
- DCM Mega Fuseholder (60V/500A)
- DCM ANL Fuseholder (60V/600A)
- DCM Class-T Fuseholder (60V/225-400A)
- DCM Class-T Fuseholder (60V/450-600A)
- DCM RBS / TBP



Link Plate 50 mm

Link Plate 3 Way 50 mm



Model ¹⁾	Art #	Max. Current ²⁾	Dimensions (L x W)	Accepts stud size
DCM Link Plate 50 mm	5079072	600A	75.0 x 25.0 mm	M8 + M10
DCM Link Plate 3 Way 50 mm	5079073	600A	125.0 x 25.0 mm	M8 + M10

¹⁾ Not compatible with "Mega (300A)" and "ANL (300A)" fuseholders
²⁾ Current capacity can be doubled by stacking two Link Plates

Side to side linking (two positions)

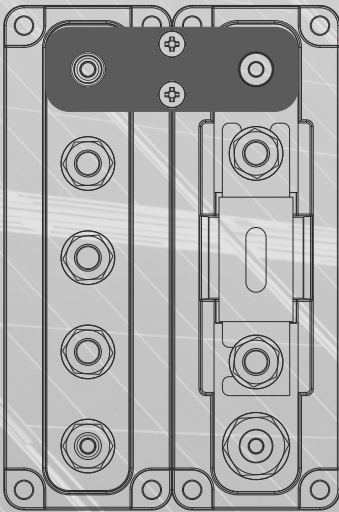

For linking to and from:

- DCM 1xM8/M10 Single Stud
- DCM 2xM8/M10 Dual Stud
- DCM 3xM8/M10 Busbar
- DCM 5xM8/M10 Busbar
- DCM Mega Fuseholder (60V/500A)
- DCM ANL Fuseholder (60V/600A)
- DCM Class-T Fuseholder (60V/225-400A)
- DCM Class-T Fuseholder (60V/450-600A)
- DCM RBS / TBP

Side to side linking (three positions)

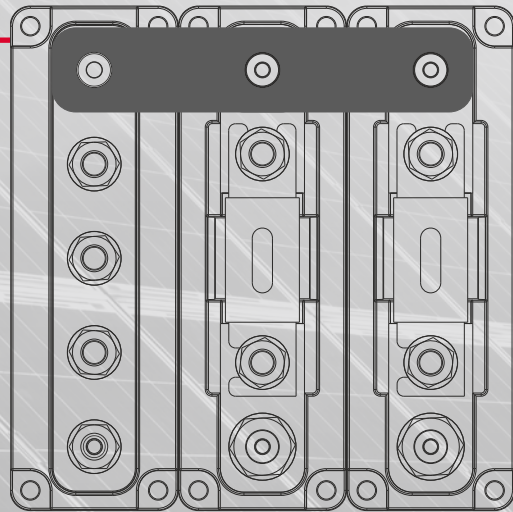

Adapter Plate



Model ¹⁾	Art #	Max. Current	Dimensions (L x W)	Accepts stud size
Adapter Plate (1xM8/M10 to 4xM4)	5079020	600A	46.0 x 25.0 mm	M8 + M10

¹⁾ Not compatible with "Mega (300A)" and "ANL (300A)" fuseholders

For converting an M8 or M10 stud to 4xM4 fork/ring terminals

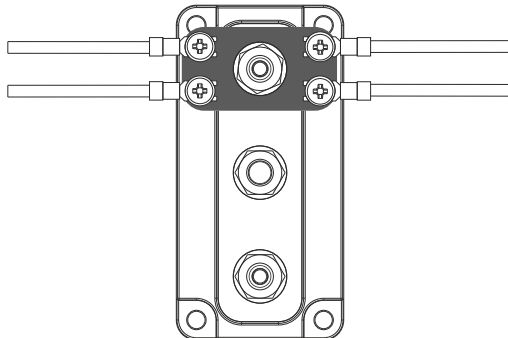

Other products



A wide range of products to complement your power system

As independent electrical systems are becoming increasingly more complex nowadays, more accessories and smaller electrical devices are needed to complement these systems. Although some of these products may individually also provide the perfect solution for a small simple system.

TBS is offering a growing number of such products, which currently consists of different DC to DC converter solutions, Automatic Charging Relays (or Battery Separators), Battery Protect Relays and Battery Isolators.

DC to DC converters

TBS is offering a wide range of DC to DC converter products with various functionalities to offer the right solution for your application. There are models equipped with or without an isolation border between the DC input and output, plus models with battery charging capabilities. Additionally, the DC to DC converter line-up can be divided into Step Down versions (input voltage is higher than output voltage) and Step Up versions (input voltage is lower than output voltage). All converters are built using robust high efficiency switch mode technology making these suitable for a wide range of application environments, like automotive, marine and industrial systems.

Automatic Charging Relay (or Battery Separator)

The TACR-160 is a smart 12V/24V-160A mechanical relay that is primary used to combine two different batteries together, when one of the two batteries is being charged. This allows both batteries to be charged by a single charging source. As soon as the charging is stopped, the TACR-160 will automatically disconnect both batteries from each other again. This avoids that one battery will discharge the other.

Besides this main functionality, the TACR-160 can also act as a remote controlled DC switch or only allowing a load to be connected to the battery when it is being charged. A remote switch can also be used to temporarily combine the auxiliary battery with the starter battery, in order to increase the available power to for example start an engine.





Battery Protect Relay

In order to protect your batteries from being discharged too deeply, a TBP Battery Protect Relay can be installed between the battery and the load. We have models available with current ratings of 60A and 200A (for 500A model see the DC Modular Contactor chapter). The 12V or 24V system voltage is automatically detected. The desired disconnect and reconnect battery voltage levels can be programmed and stored into the TBP.

The TBP devices can also be controlled remotely by a switch, to manually disconnect the load from the battery when a system is for example left unattended for a prolonged time. An alarm output can be used to connect to a buzzer that activates once an under voltage is detected.

DC to DC Converters

TDC, TDCi and TDCi-CH Series



Description

DC to DC converters are used to convert from one voltage level to another. In our lineup we are offering models with 12V, 24V or 48V inputs and 12V or 24V outputs at different power levels. The utilized switch mode technology ensures high efficiency low loss operation. Careful design and over dimensioned components ensure trouble free operation for many years. Our DC to DC converter lineup consists of three different series, TDC, TDCi and TDCi-CH. Explained below are the specific differences between each series.

The TDC series are compact non isolated DC to DC converters and have an excellent price/performance ratio. These are available in Step Down and Step Up versions and can be used in applications where the DC input source share the same ground potential as the DC output load, like in most road vehicles.

The TDCi series are isolated DC to DC converters that are also available in Step Down and Step Up versions. These models are ideal when no electrical connection between the input source and the output load is desired.

The TDCi-CH series are based on the standard TDCi products, but are equipped with an automatic battery charging functionality. This enables the possibility to charge a battery connected to the output from another battery connected to the input. One of the benefits is that the charging voltage of the input battery does not need to be exactly the same as the charge voltage requirements of the output battery, allowing two different battery types to be connected together.

Features

- Supply 12V consumers from a 24V system or vice versa
- Supply 12V or 24V consumers from a 48V system
- Charge one battery from another (TDCi-CH only)
- Compact and easy to install
- Robust industrial design
- High efficiency
- Protected against low battery voltage, high temperature and overload
- CE certified
- 24 month warranty

Applications

- Marine applications
- Electric forklifts
- All types of road vehicles
- Machine building
- Process engineering
- Industrial systems
- Mobile entertainment systems
- Building automation



Technical specifications

Model	In/out isolation (500V)	Charge functionality	Vin range (Vdc)	Vout (Vdc)	Iout (A)	Cooling	Dimensions (mm)	Weight (kg)
TDC-12/24-10 art # 5020100	X	X	9..18	25.0	10	convection	127 x 88 x 49	0.36
TDC-12/24-20 art # 5020110	X	X	9..18	25.0	20	convection	150 x 88 x 98	1.20
TDC-24/12-12 art # 5020130	X	X	20..35	13.6	12	convection	98 x 88 x 49	0.30
TDC-24/12-20 art # 5020140	X	X	20..35	13.6	20	convection	127 x 88 x 49	0.45
TDC-24/12-30 art # 5020150	X	X	20..35	13.6	30	fan	150 x 88 x 49	0.53
TDCi-12/12-16 art # 5020500	•	X	9..18	12.5	16	fan	175 x 88 x 49	0.62
TDCi-24/12-16 art # 5020510	•	X	20..35	12.5	16	fan	175 x 88 x 49	0.62
TDCi-48/12-16 art # 5020520	•	X	30..60	12.5	16	fan	175 x 88 x 49	0.62
TDCi-12/24-8 art # 5020530	•	X	9..18	24.5	8	fan	175 x 88 x 49	0.62
TDCi-24/24-8 art # 5020540	•	X	20..35	24.5	8	fan	175 x 88 x 49	0.62
TDCi-48/24-8 art # 5020550	•	X	30..60	24.5	8	fan	175 x 88 x 49	0.62
TDCi-12/12-30 art # 5020700	•	X	9..18	12.5	30	fan	190 x 132 x 83	1.36
TDCi-24/12-30 art # 5020710	•	X	20..35	12.5	30	fan	190 x 132 x 83	1.36
TDCi-48/12-30 art # 5020720	•	X	30..60	12.5	30	fan	190 x 132 x 83	1.36
TDCi-12/24-15 art # 5020730	•	X	9..18	24.5	15	fan	190 x 132 x 83	1.36
TDCi-24/24-15 art # 5020740	•	X	20..35	24.5	15	fan	190 x 132 x 83	1.36
TDCi-48/24-15 art # 5020750	•	X	30..60	24.5	15	fan	190 x 132 x 83	1.36
TDCi-12/12-20CH art # 5022000	•	•	9..18	14.4	20	convection	190 x 132 x 83	1.31
TDCi-12/24-10CH art # 5022020	•	•	9..18	28.8	10	convection	190 x 132 x 83	1.31

Note: the given specifications are subject to change without notice.

Automatic Charging Relay

TACR-160



Description

In a boat or vehicle with two battery banks, it is useful to be able to charge both banks while underway. The TACR-160 allows two battery banks to be charged from a single source, such as an alternator, but keep batteries isolated when not charging. This is to avoid that one battery bank discharges the other. Additionally, if one battery bank becomes depleted anyway, there will be a charged bank available for emergency starting.

Besides the main functionality of automatic battery combining or separation, the TACR-160 can also act as a remote controlled DC switch or only allowing a load to be connected to the battery when it is being charged. A

remote switch can also be used to temporarily combine the auxiliary battery with the starter battery, in order to increase the available power to start an engine.

Features

- Automatically combines batteries during charging, isolates batteries when discharging or at rest
- Bi-directional operation
- Automatic system voltage detection (12V/24V)
- Forced ignition combine by external switch
- Use as voltage dependent switch
- Battery/accessory protection against high voltages
- CE certified
- 24 month warranty

Applications

- Road vehicles
- Marine applications
- Hybrid generators





Technical specifications

Parameter	TACR-160 art # 5075200
Supply voltage	12Vdc / 24Vdc (auto detect)
Contact current (cont.)	160Adc
Contact current (peak)	480Adc (250ms)
Relay activation voltage	13.2Vdc (@12V) / 26.4Vdc (@24V)
Relay de-activation voltage	12.8Vdc (@12V) / 25.6Vdc (@24V)
Activation delay	5 sec.
De-activation delay	60 sec.
Quick de-activation voltage	11.8Vdc (@12V) / 23.6Vdc (@24V)
Quick de-activation delay	4 sec.
Overvoltage disconnect	16Vdc (@12V) / 32Vdc (@24V)
Current consumption (passive)	1.8mAdc (@12V) / 2.0mAdc (@24V)
Current consumption (active)	340mAdc (@12V) / 170mAdc (@24V)
Weight / dimensions	470 gr. / 108 x 72 x 58mm (L x W x H)
Connections	M8 (A1 & A2) + 6.3mm male Faston (other)

Note: the given specifications are subject to change without notice.

Battery Protect Relays

TBP-60 and TBP-200



Description

A TBP Battery Protect Relay protects your batteries from non essential loads before the battery is completely discharged. Causing damage to batteries and potentially a shortage of cranking power to start your engine. These (solid state-) relays also protect connected electrical appliances against over voltage. The battery load is disconnected whenever the DC voltage goes beyond 16V (12V mode) or 32V (24V mode).

The TBP products are microprocessor controlled and contain 10 user selectable programs for different disconnect and reconnect voltages.

A TBP relay can also be controlled remotely by a switch, to manually disconnect the load from the battery when a system is for example left unattended for a prolonged time. An alarm output can be used to connect to a buzzer that activates once an under voltage is detected.

Features

- Protects your battery from being discharged too deeply
- Protects battery loads against high voltages
- Remote switch connection
- Alarm output
- 10 programs available for different disconnect / reconnect voltages
- CE certified
- 24 month warranty

Applications

- Recreational vehicles
- Service vehicles
- Marine applications
- Industrial systems



Technical specifications

Parameter	TBP-60 art # 5074100	TBP-200 art # 5074200
Operating voltage	12Vdc / 24Vdc (auto detect)	
High voltage disconnect	16V (12V mode) / 32V (24V mode)	
Maximum load / shutdown current	60..65A	200..210A
Maximum surge current	120A	480A
Voltage drop	0.15V @ 60A	0.13V @ 200A
Current consumption	4mA (output active) / 2mA (output inactive)	
Shutdown delay at overload	5 sec. (auto reconnect after 1 minute)	
Measurement accuracy	±2% (voltage) / ±20% (current)	
Disconnect / reconnect voltages (10 user selectable programs)	12V mode:	24V mode:
	10.5V / 12.0V	21.0V / 24.0V
	10.0V / 11.5V	20.0V / 23.0V
	9.5V / 11.5V	19.0V / 23.0V
	11.3V / 13.3V	22.6V / 26.6V
	11.5V / 13.8V	23.0V / 27.6V
	10.5V / 12.8V	21.0V / 25.6V
	11.5V / 12.8V	23.0V / 25.6V
	11.8V / 12.8V	23.6V / 25.6V
	12.0V / 13.0V	24.0V / 26.0V
10.0V / 13.2V	20.0V / 26.4V	
Protection class	IP66	
Dimensions	82 x 65 x 41 mm	120 x 112 x 61.0 mm
Weight	0.2 kg	0.7 kg
Connections	M6 + 6.3 mm fastons	M10 + 6.3 mm fastons

Note: the given specifications are subject to change without notice.



Tip!

For a similar product, but with a 500A current rating, please check the DCM Battery Protect Relay in our DC Modular product lineup.



tbs electronics
THE POWER OF QUALITY

De Marowijne 3, 1689 AR Zwaag
The Netherlands

tbs-electronics.com

TBSCAT-EN-REVD